

**STATE OF UTAH
DIVISION OF WATER QUALITY
SALT LAKE CITY, UTAH 84114-4870**

**Ground Water Discharge Permit
Permit No. UGW570002**

In compliance with the provisions of the Utah Water Quality Act, Title 19, Chapter 5, Utah Code Annotated (UCA) 1953, as amended, the Act,

**SUNNYSIDE COGENERATION ASSOCIATES (SCA)
PO Box 10
East Carbon, Utah 84520**

is granted a Ground Water Discharge Permit for the operation of the SCA #1 Ash Landfill and the SCA #2 Ash Landfill associated with the Sunnyside Cogeneration Associates Plant located at Sunnyside in Carbon County, Utah.

The SCA #1 Ash Landfill is located on a tract of land within the northeast quarter of Section 12 Township 15 South Range 13 East, Salt Lake Base and Meridian. (110° 24' 38" W. Long. and 39° 32' 23" N. Lat.) The SCA #2 Ash Landfill is located on a tract of land within the NE quarter of Section 7 and NW quarter of Section 8 with additional access routes in Section 6 and the SW quarter of Section 5 Township 15 South Range 14 East, Salt Lake Base and Meridian. (110° 22' W. Long. & 39° 32' N. Lat.)

The permit is based on representations made by the Permittee and other information contained in the administrative record. It is the responsibility of the Permittee to read and understand all provisions of this permit.

The facilities shall be constructed and operated in accordance with conditions set forth in the permit and the Utah Ground Water Quality Protection Regulations.

This permit shall become effective on June 10th, 2020.

This permit and the authorization to operate shall expire at midnight, June 9th, 2025.



Erica Brown Gaddis, PhD
Director
Utah Division of Water Quality

TABLE OF CONTENTS

I.	SPECIFIC PERMIT CONDITIONS	Page 3
A.	Ground Water Classification	Page 3
B.	Background Water Quality	Page 3
C.	Ground Water Protection Levels	Page 4
D.	Best Available Technology Standard	Page 5
E.	Compliance Monitoring	Page 7
F.	Non-Compliance Status	Page 9
G.	Reporting Requirements	Page 11
H.	Compliance Schedule	Page 11
II.	MONITORING, RECORDING AND REPORTING REQUIREMENTS	Page 12
A.	Representative Sampling	Page 12
B.	Analytical Procedures	Page 12
C.	Penalties for Tampering	Page 12
D.	Reporting of Monitoring Results	Page 12
E.	Compliance Schedules	Page 12
F.	Additional Monitoring by the Permittee	Page 13
G.	Records Contents	Page 13
H.	Retention of Records	Page 13
I.	Twenty-four Hour Notice of Noncompliance Reporting	Page 13
J.	Other Noncompliance Reporting	Page 14
K.	Inspection and Entry	Page 14
III.	COMPLIANCE RESPONSIBILITIES	Page 15
A.	Duty to Comply	Page 15
B.	Penalties for Violations of Permit Conditions	Page 15
C.	Need to Halt or Reduce Activity not a Defense	Page 15
D.	Duty to Mitigate	Page 15
E.	Proper Operation and Maintenance	Page 15
IV.	GENERAL REQUIREMENTS.....	Page 16
A.	Planned Changes	Page 16
B.	Anticipated Noncompliance	Page 16
C.	Permit Actions	Page 16
D.	Duty to Reapply	Page 16
E.	Duty to Provide Information	Page 16
F.	Other Information	Page 16
G.	Signatory Requirements	Page 16
H.	Penalties for Falsification of Reports	Page 18
I.	Availability of Reports	Page 18
J.	Property Rights	Page 18
K.	Severability	Page 18
L.	Transfers	Page 18
M.	State Laws	Page 19
N.	Reopener Provision	Page 19
TABLES		
1	SCA #1 Background Water Quality.....	Page 3
2	SCA #2 Background Water Quality.....	Page 4
3	SCA #1 Groundwater Protection Levels.....	Page 4
4	SCA #2 Groundwater Protection Levels.....	Page 5

I. SPECIFIC PERMIT CONDITIONS

A. Ground Water Classification

Monitoring data have shown variable ground water quality across the site. Ground water which is contained in or which has come in contact with the Mancos Shale may be Class III, Limited use Ground Water. The ground water classification for the alluvial aquifer associated with Icelander Creek in the immediate vicinity of the SCA#1 Phase II and III Ash Landfill has come in contact with the Mancos Shale and is Class III - Limited Use Ground Water. The ground water classification of the aquifer associated with SCA #2 Ash Landfill is Class IV – Saline Ground Water due to high total dissolved solids (TDS) concentrations and background selenium concentrations above Ground Water Quality Standards, defined under Utah Administrative Code (UAC) R317-6-2.

B. Background Water Quality

Background water quality for the Icelander Creek alluvial aquifer associated with the SCA#1 Phase II and III Ash Landfill has been established from ground water monitoring results from well MW-7 between February 1998 and December 1999 (nine samples). Background water quality for SCA#1 at MW-7 is presented in Table 1.

Table 1
SCA #1 Background Water Quality

<u>Constituent</u>	<u>Mean Background Concentration, mg/L</u>	<u>Standard Deviation</u>
Calcium	138	159
Sodium	1,378	148
Potassium	17.6	15.8
Magnesium	49	49
Chloride	389	32
Sulfate	1,318	217
Bicarbonate	1,448	346
Carbonate	13	15

Background water quality for the upper Icelander Creek alluvial aquifer associated with the SCA#2 Ash Landfill has been established from ground water monitoring results from MW-8. Values represented in Table 2 were derived from 10 samples taken from MW-8 between January 2012 and January 2013.

Table 2
SCA# 2 Background Water Quality

<u>Constituent</u>	<u>Mean Background Concentration, mg/L</u>	<u>Standard Deviation</u>
Calcium	387.2	14.6
Sodium	1,392	106
Potassium	18.64	0.8
Magnesium	777.5	22.7
Chloride	238.8	15.4
Sulfate	5.662	1,223
Bicarbonate	491.8	5.1
Carbonate	ND	ND

C. Ground Water Protection Levels

Ground water protection levels for downgradient well MW-7 associated with SCA #1 (Phase II and III) Ash Landfill for this permit are represented in Table 3.

Table 3
SCA#1 (Phase II and III) Ground Water Protection Levels

<u>Constituent</u>	<u>MW-7 Background Value (mg/L)</u>	<u>MW-7 Protection Level (mg/L)</u>
pH	7.98 units	6.5-8.5 units
TDS	4,290	5,363 ¹
Arsenic	0.006	0.025 ²
Barium	0.194	1.0 ²
Cadmium	<0.003	0.0025 ²
Copper	0.018	0.65 ²
Lead	<0.01	0.0075 ²
Selenium	0.0167	0.025 ²
Silver	0.0011	0.05 ²
Zinc	0.037	2.5 ²

1. 1.25 x background concentration for TDS
2. 0.5 x Ground Water Quality Standard for Class III Ground Water

Ground water protection levels for downgradient well MW-8 associated with SCA #2 Ash Landfill for this permit are represented in Table 4.

Table 4
SCA #2 Ground Water Protection Levels

<u>Constituent</u>	<u>MW-8 Background Value (mg/L)</u>	<u>MW-8 Protection Level (mg/L)</u>
pH	7.16 units	6.1-8.5 units
TDS	10,256	12,820 ¹
Arsenic	0.0086	0.025 ²
Barium	0.012	1.0 ²
Cadmium	ND	0.0025 ²
Copper	ND	0.65 ²
Lead	ND	0.0075 ²
Selenium	0.0573	0.1 ³
Silver	ND	0.05 ²
Zinc	ND	2.5 ²

1. 1.25 x background concentration for TDS
2. 0.5 x Ground Water Quality Standard for Class IV Ground Water
3. 2 x Ground Water Quality Standard for Class IV Ground Water for Selenium

D. Best Available Technology Standard

1. Authorized Construction and Operations
 - a) The SCA #1 (Phase I, II, and III) and SCA#2 Ash Landfills have been operated as a landfill strictly for disposal of ash generated from the burning of coal refuse obtained from the adjacent SCA coal refuse pile and Star Point coal refuse pile, or other similar refuse sources, and other coal based fuels [alternative fuels], limestone reagent added to control SO₂ emissions, and fuel oil or other high BTU coal (supplemental fuel) as limited by the FERC certification dated February 11, 1992, as supplemented by the Notice of Self-Certification of Sunnyside Cogeneration Associates as a Qualifying Small Power Production Facility in Docket No. QF86-556-004 filed April 19, 2000. While being loaded into trucks destined for the landfill, such ash will be conditioned with slurry containing water and water treatment solids. No other material is authorized for disposal by this permit in the Ash Disposal Area.

At the present time, the SCA #1 Phase I ash disposal area has completed the post closure monitoring period. The SCA#1 Phase II and III ash disposal area are now capped and in the 10-year post-closure period which began in August 2016.

A Construction Permit was issued to Sunnyside Cogeneration Associates on September 4, 2014 approving the construction of the SCA #2 Ash Landfill of approximately 34 acres plus surrounding access and drainage facilities (Appendix A).

2. Design and Construction

- a) *SCA #1 Ash Landfill Phase I Disposal Area* - The existing ash disposal was been constructed as previously designed and approved and is now closed, capped and re-seeded according to specifications. The 10-year post-closure period was completed in 2008.
- b) *SCA #1 Ash Landfill Phase II and III Disposal Area* – The ash disposal area was constructed as previously designed and approved and is now closed, capped and re-seeded according to specifications. The Phase II and III landfill is now in the 10-year post-closure monitoring period, which began in August 2016.
- c) *SCA #2 Ash Landfill* - The SCA #2 Ash Landfill will be constructed according to drawings dated April 2014 (Appendix A) and will follow material placement techniques demonstrated at the SCA #1 Ash Landfill. Because of minimal lateral extent of soil and vegetative covering, removal of these materials will not be required and will have no consequences regarding the ash placement in the expanded area. Ash will be placed in 12-inch lifts and compacted. Ash will be configured in maximum 60-foot high terraces with a projected outslope of 3 horizontal to 1 vertical (maximum allowed 2H:1V). A 15-foot wide bench will be constructed at the top of each terrace. The bench will be sloped to control drainage. Drainage from the toe of each terrace will be routed through sediment traps and to the sedimentation basin at the bottom of the disposal area. The SCA #2 area will be approximately 34 acres, plus surrounding access and drainage facilities. The cap and reclamation plan will include a compacted 6 to 8-inch soil cap (import soil 2" minus with >30% passing the #200 sieve) plus an 18 to 24-inch loose thickness native soil cover with fertilizer, mulch and surface roughening.

3. Run-on and Run-off Control

Surface water run-on will be controlled by site grading and ditches to direct drainage away from the SCA #1 Ash Landfill Phase I, II, and III Disposal Areas and from the SCA #2 Ash Landfill.

4. Sediment Basins

Storm water and ash-contact run-off is collected in the sediment basins. These basins approved and permitted by the UPDES process for surface discharge to Iceland Creek (UPDES Permit UT0024759).

E. Compliance Monitoring

1. Compliance Monitoring Points

Sunnyside Cogeneration Associates shall operate ground water monitoring points as follows:

- a) *SCA#1 Ash Landfill Phase II and III Disposal Area* - Monitoring well MW-7 will serve as the downgradient monitoring point.
- b) *SCA#2 Ash Landfill* – Monitoring well MW-8 will serve as the down-gradient monitoring point. Due to the uphill cliff topography of the site, no up-gradient monitoring point exists.
- c) All monitoring wells are constructed in accordance with criteria contained in the EPA RCRA Ground Water Monitoring Technical Enforcement Guidance Document, 1986, OSWER-9950.1 (RCRA TEGD).

2. Future Modification of the Monitoring Well Network

If at any time the Division Director determines the monitoring program to be inadequate, Sunnyside Cogeneration Associates shall submit within 30 days of receipt of written notice from the Division Director a modified monitoring plan that addresses the inadequacies noted by the Division Director.

3. Compliance Monitoring Period

Monitoring shall commence upon issuance of this permit and shall continue at each ash landfill through a 10 year period following final closure of that ash landfill.

4. Monitoring Frequency

The ground water monitoring wells will be sampled semi-annually while the corresponding ash disposal landfill is open, according to the requirements of Part I.E.5(c).

5. Monitoring Requirements

- a) In association with each sampling event, water level measurements shall be made in each monitoring well prior to removal of any water from the well bore. Measurements will be made from a permanent single reference point clearly marked on the top of the well or surface casing. Measurements will be made to the nearest 0.01 foot, and reported as elevation above sea level.
- b) Water quality samples will be collected, handled and analyzed in conformance with the Water Quality Sampling Plan that has been approved by the Division Director. Sampling at additional surface

water monitor points shall be done according to the Water Quality Sampling Plan.

- c) The following analyses shall be performed on all compliance monitoring samples collected:
 - i) Field Measurements: pH, specific conductance, temperature
 - ii) Laboratory Analysis:
 - Major Ions: (Chloride, Sulfate, Carbonate, Bicarbonate, Sodium, Potassium, Magnesium, and Calcium)
 - TDS
 - Metals:(As, Ba, Cd, Cu, Pb, Se, Ag, Zn)
- d) Ash leachate analysis shall be done every five years beginning with permit issuance in 1992 according to the revised approved Ash Leachate Analysis.

6. Post Closure Monitoring

The Permittee shall conduct monitoring after final capping and closure of each Ash Disposal Area Phase on a semiannual frequency for a period of 10 years after final closure. Water Quality sampling from the monitoring wells will include the same field and lab analysis contained in Part I.E.5(c).

7. Laboratory Approval

All water quality analyses shall be performed by a laboratory certified by the State of Utah to perform such analysis.

F. Non-Compliance Status

1. Probable Out-of-Compliance Status

Other than as provided in paragraph I.F.2 below, Sunnyside Cogeneration Associates shall evaluate the results of each round of ground water sampling analytical results to determine any exceedance of the Ground Water Protection Levels outlined in Part I Tables 3 or 4. Upon determination by Sunnyside Cogeneration Associates that a Protection Level has been exceeded, at any compliance monitoring well, Sunnyside Cogeneration Associates shall:

- a) Immediately re-sample the exceeding monitoring well(s), submit analytical results from the re-sampling, and notify the Division Director of the probable out-of-compliance status within 30 days of initial detection.

- b) Implement a monthly frequency of sampling for the ground water monitoring well(s) required by this permit. The monthly frequency shall continue until the Division Director notifies Sunnyside Cogeneration Associates that the permitted monitoring frequency can be resumed.

2. Probable Out-of-Compliance Status for Total Dissolved Solids

In the event total dissolved solids (TDS) exceeds 5,363 mg/L in well MW-7; or 12,820 mg/L in well MW-8; and no other parameters exceed Protection Levels, the Permittee shall prepare a report on the cause of the exceedance for submission with the next regular monitoring report. This report must show an analysis of major ion chemistry at all monitoring points for the current sampling event and any past data needed to evaluate the cause of the exceedance. If the Exceedance Report fails to identify the probable cause for exceeding the Protection Limits in Tables 3 or 4, the analysis shall include Piper and Stiff diagrams for water chemistry of the monitoring points, ash leachate, and leachate from naturally occurring materials at the site, and water from the ash runoff basin. Other information, such as trend analysis, may also be presented to support the report's conclusions.

In the event the report does not satisfactorily demonstrate that the TDS exceedance was caused by factors other than that of the landfill, the Permittee shall follow the procedures in Parts I.F.1 and 3, as applicable. Based on available information, the Division Director may require changes in the compliance-monitoring plan to better monitor the landfill's effects on ground water.

3. Out-of-Compliance Status due to Exceedence of Permit Limits

Based on the accelerated monitoring results obtained under monthly sampling as listed in Part I.F.1, Sunnyside Cogeneration Associates shall determine in accordance with UAC R317-6-6.16, if an out of compliance situation exists. Upon making this determination Sunnyside Cogeneration Associates shall:

- a) Notify the Division Director of the out of compliance status within 24 hours of detection.
- b) Submit a Source Assessment and Compliance Schedule to the Division Director within 30 days of detection of the out of compliance status that outlines the following:
 - i) Steps of action that will assess the extent of the contamination and identify its source.
 - ii) Measures that will be taken to alleviate contribution of any further contamination to the ground water and prevent any recurrence of the non-compliance.

iii) Actions that will be taken to mitigate and remediate existing contamination from the implicated facility.

- c) Implement the Source Assessment and Compliance Schedule within 120 days of approval by the Division Director.

4. Out-of-Compliance Status due to Failure of Best Available Technology

If the Permittee determines that an out of compliance situation exists due to failure to maintain best available technology, Sunnyside Cogeneration Associates shall notify the Division Director according to the provisions of this permit.

In the event a compliance action is initiated against the Permittee for violation of permit conditions relating to containment technology, the Permittee may affirmatively defend against that action by demonstrating the following:

- a) The Permittee submitted notification according to the provisions of this permit.
- b) The failure was not intentional or caused by the Permittee's negligence, either in action or failure to act.
- c) The Permittee has taken adequate measures to meet permit conditions in a timely manner or has submitted to the Division Director, for his approval, an adequate plan and schedule for meeting permit conditions; and
- d) The provisions of Utah Code Ann. § 19-5-107 have not been violated.

G. Reporting Requirements

1. Reporting

Water quality sampling results shall be submitted to the Division Director as follows:

<u>Semi-Annual Sampling</u>	<u>Report Due On</u>
1 st (Jan., Feb., March, April, May, June)	July 15
2 nd (July, Aug., Sept., Oct., Nov., Dec.)	January 15

Failure to submit reports within the time frame due shall be deemed as noncompliance and may result in enforcement action.

H. Compliance Schedule

Reports of compliance or noncompliance with, or any progress report on interim and final requirements contained in any compliance schedule of this permit shall be no later than 14 days following each schedule date.

II. MONITORING, RECORDING AND REPORTING REQUIREMENTS

A. Representative Sampling

Samples taken in compliance with the monitoring requirements established under Part I shall be representative of the monitored activity.

B. Analytical Procedures

Water sample analysis must be conducted according to test procedures specified under UAC R317-6-6.3.L, unless other test procedures have been specified in this permit.

C. Penalties for Tampering

The Act provides that any person who falsifies, tampers with, or knowingly renders inaccurate, any monitoring device or method required to be maintained under this permit shall, upon conviction, be punished by a fine of not more than \$10,000 per violation, or by imprisonment for not more than six months per violation, or by both.

D. Reporting of Monitoring Results

Monitoring results obtained during each reporting period specified in the permit, shall be submitted to the Division Director, Utah Division of Water Quality at the following address no later than the 15th day of the month following the completed reporting period:

State of Utah
Division of Water Quality
Department of Environmental Quality
P.O. Box 144870
Salt Lake City, Utah 84114-4870
Attention: Ground Water Protection Program

Electronic Document Submission:

<https://deq.utah.gov/water-quality/water-quality-electronic-submissions>

E. Compliance Schedules

Reports of compliance or noncompliance with, or any progress reports on interim and final requirements contained in any Compliance Schedule of this permit shall be submitted no later than 14 days following each schedule date.

F. Additional Monitoring by the Permittee

If the Permittee monitors any pollutant more frequently than required by this permit, using approved test procedures as specified in this permit, the results of

this monitoring shall be included in the calculation and reporting of the data submitted. Such increased frequency shall also be indicated.

G. Records Contents

Records of monitoring information shall include:

1. The date, exact place, and time of sampling or measurements;
2. The individual(s) who performed the sampling or measurements;
3. The date(s) and time(s) analyses were performed;
4. The individual(s) who performed the analyses;
5. The analytical techniques or methods used; and,
6. The results of such analyses.

H. Retention of Records

The Permittee shall retain records of all monitoring information, including all calibration and maintenance records and copies of all reports required by this permit, and records of all data used to complete the application for this permit, for a period of at least three (3) years from the date of the sample, measurement, report or application. This period may be extended by request of the Division Director at any time.

I. Twenty-four Hour Notice of Noncompliance Reporting

1. The Permittee shall verbally report any noncompliance that may endanger public health or the environment as soon as possible, but no later than twenty-four (24) hours from the time the Permittee first became aware of the circumstances. The report shall be made to the Utah Department of Environmental Quality 24 hour number, (801) 536-4123, or to the Division of Water Quality, Ground Water Protection Section at (801) 536-4300, during normal business hours (8:00 am - 5:00 pm Mountain Time).
2. A written submission shall also be provided to the Division Director within five days of the time that the Permittee becomes aware of the circumstances. The written submission shall contain:
 - a. A description of the noncompliance and its cause;
 - b. The period of noncompliance, including exact dates and times;
 - c. The estimated time noncompliance is expected to continue if it has not been corrected; and,
 - d. Steps taken or planned to reduce, eliminate, and prevent reoccurrence of the noncompliance.
3. Reports shall be submitted to the addresses in Part II D, Reporting of Monitoring Results.

J. Other Noncompliance Reporting

Instances of noncompliance not required to be reported within 24 hours, shall be reported at the time that monitoring reports for Part III D are submitted.

K. Inspection and Entry

The Permittee shall allow the Division Director, or an authorized representative, upon the presentation of credentials and other documents as may be required by law, to:

1. Enter upon the Permittee's premises where a regulated facility or activity is located or conducted, or where records must be kept under the conditions of the permit;
2. Have access to and copy, at reasonable times, any records that must be kept under the conditions of this permit;
3. Inspect at reasonable times any facilities, equipment (including monitoring and control equipment), practices, or operations regulated or required under this permit; and,
4. Sample or monitor at reasonable times, for the purpose of assuring permit compliance or as otherwise authorized by the Act, any substances or parameters at any location.

III. COMPLIANCE RESPONSIBILITIES

A. Duty to Comply

The Permittee must comply with all conditions of this permit. Any permit noncompliance constitutes a violation of the Act and is grounds for enforcement action; for permit termination, revocation and reissuance, or modification; or for denial of a permit renewal application. The Permittee shall give advance notice to the Division Director of any planned changes in the permitted facility or activity that may result in noncompliance with permit requirements.

B. Penalties for Violations of Permit Conditions

The Act provides that any person who violates a permit condition implementing provisions of the Act is subject to a civil penalty not to exceed \$10,000 per day of such violation. Any person who willfully or negligently violates permit conditions is subject to a fine not exceeding \$25,000 per day of violation. Any person convicted under Section 19-5-115(2) of the Act a second time shall be punished by a fine not exceeding \$50,000 per day. Nothing in this permit shall be construed to relieve the Permittee of the civil or criminal penalties for noncompliance.

C. Need to Halt or Reduce Activity not a Defense

It shall not be a defense for a Permittee in an enforcement action that it would have been necessary to halt or reduce the permitted activity in order to maintain compliance with the conditions of this permit.

D. Duty to Mitigate

The Permittee shall take all reasonable steps to minimize or prevent any discharge in violation of this permit that has a reasonable likelihood of adversely affecting human health or the environment.

E. Proper Operation and Maintenance

The Permittee shall at all times properly operate and maintain all facilities and systems of treatment and control (and related appurtenances) which are installed or used by the Permittee to achieve compliance with the conditions of this permit. Proper operation and maintenance also includes adequate laboratory controls and quality assurance procedures. This provision requires the operation of back-up or auxiliary facilities or similar systems that are installed by a Permittee only when the operation is necessary to achieve compliance with the conditions of the permit.

IV. GENERAL REQUIREMENTS

A. Planned Changes

The Permittee shall give notice to the Division Director as soon as possible of any planned physical alterations or additions to the permitted facility. Notice is required when the alteration or addition could significantly change the nature of the facility or increase the quantity of pollutants discharged.

B. Anticipated Noncompliance

The Permittee shall give advance notice of any planned changes in the permitted facility or activity that may result in noncompliance with permit requirements.

C. Permit Actions

This permit may be modified, revoked and reissued, or terminated for cause. The filing of a request by the Permittee for a permit modification, revocation and reissuance, or termination, or a notification of planned changes or anticipated noncompliance, does not stay any permit condition.

D. Duty to Reapply

If the Permittee wishes to continue an activity regulated by this permit after the expiration date of this permit, the Permittee must apply for and obtain a permit renewal or extension. The application should be submitted at least 180 days before the expiration date of this permit.

E. Duty to Provide Information

The Permittee shall furnish to the Division Director, within a reasonable time, any information which the Division Director may request to determine whether cause exists for modifying, revoking and reissuing, or terminating this permit, or to determine compliance with this permit. The Permittee shall also furnish to the Division Director, upon request, copies of records required to be kept by this permit.

F. Other Information

When the Permittee becomes aware that it failed to submit any relevant facts in a permit application, or submitted incorrect information in a permit application or any report to the Division Director, it shall promptly submit such facts or information.

G. Signatory Requirements

All applications, reports or information submitted to the Division Director shall be signed and certified.

1. All permit applications shall be signed as follows:
 - a. For a corporation: by a responsible corporate officer;
 - b. For a partnership or sole proprietorship: by a general partner or the proprietor, respectively.
 - c. For a municipality, State, Federal, or other public agency: by either a principal executive officer or ranking elected official.

2. All reports required by the permit and other information requested by the Division Director shall be signed by a person described above or by a duly authorized representative of that person. A person is a duly authorized representative only if:
 - a. The authorization is made in writing by a person described above and submitted to the Division Director, and,
 - b. The authorization specified either an individual or a position having responsibility for the overall operation of the regulated facility or activity, such as the position of plant manager, operator of a well or a well field, superintendent, position of equivalent responsibility, or an individual or position having overall responsibility for environmental matters for the company. (A duly authorized representative may thus be either a named individual or any individual occupying a named position.)

3. Changes to Authorization. If authorization under Part IV.G.2 is no longer accurate because a different individual or position has responsibility for the overall operation of the facility, a new authorization satisfying the requirements of Part IV.G.2. must be submitted to the Division Director prior to or together with any reports, information, or applications to be signed by an authorized representative.

4. Certification. Any person signing a document under this section shall make the following certification:

"I certify under penalty of law that this document and all attachments were prepared under my direction or supervision in accordance with a system designed to assure that qualified personnel properly gather and evaluate the information submitted. Based on my inquiry of the person or persons who manage the system, or those persons directly responsible for gathering the information, the information submitted is, to the best of my knowledge and belief, true, accurate, and complete. I am aware that there are significant penalties for submitting false information, including the possibility of fine and imprisonment for knowing violations."

H. Penalties for Falsification of Reports

The Act provides that any person who knowingly makes any false statement, representation, or certification in any record or other document submitted or required to be maintained under this permit, including monitoring reports or reports of compliance or noncompliance shall, upon conviction be punished by a fine of not more than \$10,000 per violation, or by imprisonment for not more than six months per violation, or by both.

I. Availability of Reports

Except for data determined to be confidential by the Permittee, all reports prepared in accordance with the terms of this permit shall be available for public inspection at the offices of the Division Director. As required by the Act, permit applications, permits, effluent data, and ground water quality data shall not be considered confidential.

J. Property Rights

The issuance of this permit does not convey any property rights of any sort, or any exclusive privileges, nor does it authorize any injury to private property or any invasion of personal rights, nor any infringement of federal, state or local laws or regulations.

K. Severability

The provisions of this permit are severable, and if any provision of this permit, or the application of any provision of this permit to any circumstance, is held invalid, the application of such provision to other circumstances, and the remainder of this permit, shall not be affected thereby.

L. Transfers

This permit may be automatically transferred to a new Permittee if:

1. The current Permittee notifies the Division Director at least 30 days in advance of the proposed transfer date;
2. The notice includes a written agreement between the existing and new Permittee containing a specific date for transfer of permit responsibility, coverage, and liability between them; and,
3. The Division Director does not notify the existing Permittee and the proposed new Permittee of his or her intent to modify, or revoke and reissue the permit. If this notice is not received, the transfer is effective on the date specified in the agreement mentioned in Paragraph 2 above.

M. State Laws

Nothing in this permit shall be construed to preclude the institution of any legal action or relieve the Permittee from any responsibilities, liabilities, penalties established pursuant to any applicable state law or regulation under authority preserved by Section 19-5-117 of the Act.

N. Reopener Provision

This permit may be reopened and modified (following proper administrative procedures) to include the appropriate limitations and compliance schedule, if necessary, if one or more of the following events occurs:

1. If new ground water standards are adopted by the Board, the permit may be reopened and modified to extend the terms of the permit or to include pollutants covered by new standards. The Permittee may apply for a variance under the conditions outlined in R317-6.4(D).
2. If alternative compliance mechanisms are required.
3. If subsequent ground water monitoring data reveals the background water quality values in Part I Tables 1, 2, 3 or 4 are not accurate.
4. If data collected subsequent to permit issuance indicate that the fresh water reservoir and or the coal runoff basin present risks to ground water quality.

APPENDIX A

SCA#2 Construction Permit (September 4, 2014)

(DWQ-2020-012657)



State of Utah

GARY R. HERBERT
Governor

SPENCER J. COX
Lieutenant Governor

Department of
Environmental Quality

Amanda Smith
Executive Director

DIVISION OF WATER QUALITY
Walter L. Baker, P.E.
Director

FILE COPY

SEP 04 2014

Rusty Netz
Sunnyside Cogeneration Associates
P.O. Box 10
East Carbon, UT 84520



Dear Mr. Netz:

Subject: **Construction Permit** for Sunnyside Cogeneration Associates
SCA #2 Ash Landfill

On July 1, 2013, the Division of Water Quality (DWQ) received the preliminary engineering plans and specifications for Sunnyside Cogeneration Associates SCA #2 Ash Landfill prepared by Twin Peaks Engineering and Land Surveying (Twin Peaks). After reviewing the various documents there was some confusion concerning the drawings, therefore on February 27, 2014 we met with Scott Carlson of Twin Peaks to work through those issues and he indicated that a new set of Construction Drawings and additional information would be submitted. On April 3, 2014, DWQ received the new Construction Permit Submittal.

The following is a summary of the proposed major construction projects:

- Proposed Landfill Layout,
- Drainage Plan,
- Sediment Pond #018,
- Sediment Trap #1, and
- Sediment Trap #2.

The plans and specifications, as submitted, comply with *the Utah Water Quality Rules, (R317, Utah Administrative Code)*. A **Construction Permit** is hereby issued as constituted by this letter, subject to the following conditions:

1. *Any revisions or modifications to the approved plans and specifications must be submitted to DWQ for review and approval, before construction or implementation thereof. Please submit any changes for review and approval directly to Woodrow Campbell, P.E., of the DWQ Ground Water Protection Section.*

2. *A written operations and maintenance manual, containing a description of the functioning of the facilities, an outline of routine maintenance procedures, and all checklists and maintenance logs needed for proper operation of the system, must be submitted and approved before the final inspection and operation of the system.*
3. *The approved facilities must not be placed in service unless DWQ has conducted a final inspection, reviewed and approved the As-Built Construction Certification Report, and provided written authorization to place the constructed facilities in service.*
4. *Construction activities that disturb one acre or more are required to obtain coverage under the Utah Discharge Elimination System (UPDES) Storm Water General Permit for Construction Activities. The permit requires the development of a storm water pollution prevention plan (SWPPP) to be implemented and updated from the commencement of any soil disturbing activities at the site until final stabilization of the project. For more information, or to obtain permit coverage online, please go to: <http://www.waterquality.utah.gov/UPDES/stormwater.htm>.*

The plans and specifications for this project have been stamped and signed by a Professional Engineer currently licensed to practice in the state of Utah. The construction design, inspection supervision, and written construction certification of all work associated with this Construction Permit must be performed by a Professional Engineer licensed to practice in the state of Utah.

This Construction Permit will expire one year from the date of its issuance, as evidenced by the date of this letter, unless substantial progress is made in constructing the approved facilities or the plans and specifications have been resubmitted and the construction permit is reissued. This permit does not relieve you, in any way, of your obligations to comply with other applicable local requirements. You may contact Southeastern Utah District Health Department at 435.637.3671 or Dave Ariotti, District Engineer at 435.637.3671 for further assistance regarding local matters.

Please contact Mr. Campbell at the beginning of construction to allow periodic inspections to be scheduled.

Upon completion of the project, a final inspection and approval of the As-Built Construction Certification Report is required before the approval to operate the completed facilities can be issued. Please remain in contact with Mr. Campbell to schedule the final inspection. The Construction Certification Report with final as-built drawings must include test results for the following construction quality assurance and quality control (CQA/QC) elements:

Soil Subgrade and Liners

- Proctor Curves,
- Soil Classification,
- Field Compaction Testing, and
- Subgrade Acceptance Certification.

Mr. Netz

Page 3

If we can be of further assistance, please contact Mr. Woodrow Campbell at wwcampbell@utah.gov or (801) 536-4353.

Sincerely,



Walter L. Baker, P.E.

Director

WLB:WWC:DJH:mc

Enclosures: Sunnyside Cogeneration Plans and Specifications

cc: Dave Ariotti, District Engineer (via e-mail)
Southeastern Utah District Health Department (via e-mail)
Twin Peaks, 2264 North 1450 East, Lehi, UT 84043 (via e-mail)
John Barth, Barth Law Offices (via e-mail)
Rob Dubuc, Western Rivers Advocates (via e-mail)
Brian Burnett, CNM Law (via e-mail)
Sandra Allen, Attorney General's Office (via e-mail)
Paul Mcconkie, Attorney General's Office (via e-mail)

DWQ-2014-005170

FILE COPY

Sunnyside Cogeneration Associates

CONSTRUCTION PERMIT ISSUED BY
Utah Department of Environmental Quality
Utah Division of Water Quality

Date: 4/3/2014

Review Engineer: JWC
Director: [Signature]

***SCA #2 Ash Landfill
DEQ Construction Permit Submittal***



April 2014

**Permit Application Report
SCA #2 Ash Landfill
Groundwater Permit No. UGW070002**

**Sunnyside Cogeneration Associates
PO Box 159
Sunnyside UT 84539
(435) 888-4476**

24 Document Date 4/3/2014



DWQ-2014-004882

Table of Contents

	Page
1.0 Introduction	1
2.0 Executive Summary.....	1
3.0 Geotechnical Evaluation.....	3
3.1 Site Description	3
3.2 Field Investigation	3
3.3 Laboratory Testing	4
3.3.1 Strength Tests.....	4
3.4 Subsurface Conditions.....	5
3.5 Groundwater.....	5
3.6 Stability Analysis.....	6
3.7 Design Parameters.....	7
3.8 Settlement Analysis	8
3.9 Summary of Geotechnical Conclusions	9
4.0 Soil Cover Design and Reclamation.....	10
5.0 Leachate Potential.....	11
5.1 Sediment Pond #018 Liner	12
5.1.1 Proposed Hydraulic Conductivity Testing.....	13
6.0 Surface Water Controls.....	13
6.1 Existing Surface Water Features	13
6.2 Hydrologic Data	14
6.3 Design Assumptions.....	15
6.4 Hydrologic Modeling Analysis Results.....	15
6.5 Ditch Conveyance and Erosion Control.....	16
7.0 Construction QA / QC Plan	17
8.0 Operation / Maintenance Plan.....	20
9.0 Contingency and Corrective Action Plan	21

Table of Contents (cont.)

List of Appendices

Appendix A	Groundwater Sampling at MW-8
Appendix B	Hydrology Calculations
Appendix C	Geotechnical Engineering Report – PSI April 2012
Appendix D	SCA Ash Landfill #1 Leachate Modeling
Appendix E	State Engineer – Dam Permit Application and Stream Alteration Permit documents for Sediment Pond #018
Appendix F	Design Drawings – Twin Peaks 2013

Note: Appendix documents A, B, C, D & E are included with the Groundwater Permit Application Documents. They are noted here by reference.

Design drawings have been updated for the Construction Permit and are included herewith.

1.0 Introduction

The Sunnyside Cogeneration Associates (SCA) power plant burns waste fuel and provides dozens of jobs, both directly through plant operations, and indirectly through contractor positions and suppliers. SCA supplies electric power to the local power grid and is a major tax contributor to the local area. SCA is part of the overall mining and energy production industry which is an essential part of the local, state and global economy. Continued operation of SCA brings important social and economic benefits to the area. Removal of the waste fuel left behind by others through the past decades of mining in the area results in an efficient use of natural resources and reclamation of the existing refuse piles. Operations occur in a manner which protects air quality, surface waters and groundwater in the region. Ash is a byproduct of the SCA power plant and SCA has been disposing of this ash at the SCA #1 Ash Landfill a short distance west of the power plant since plant began operations in the early 1990's.

The Sunnyside Cogeneration Associates #2 Ash Landfill is a new ash landfill to be constructed on private property owned by SCA in an area approximately 1 mile to the south east of the SCA power plant. This report presents descriptions, rationale, analysis, and design computations for the engineering features of the SCA #2 Ash Landfill. This engineering report is part of a permit application package for the SCA #2 Ash Landfill.

2.0 Executive Summary

The proposed SCA #2 Ash Landfill is located in unincorporated Carbon County (Section 8, Township 14 South, Range 14 East, SLB&M) just south of the city of Sunnyside. Approximate location of the landfill is Latitude 39° 32' 24" North and Longitude 110° 22' 50" West. County zoning for this area allows for this use and Carbon County has granted a Conditional Use Permit for the SCA #2 Ash Landfill.

The proposed SCA #2 Ash Landfill is to be constructed in a small side canyon. This location was selected because it

- has a significant amount of existing disturbed area from a prior land owner,
- does not have regular surface water flows,
- is closer to the power plant and will reduce material haul distances, and
- will reduce the potential for dust near local residences.

Sediment traps and a clay lined sediment pond (#18) are proposed with the SCA #2 Ash Landfill to control storm water runoff from the landfill.

The plan, as submitted herewith, includes capacity for up to 3.6 Million cubic yards of ash material to be placed within a landfill footprint of approximately 34 acres with a maximum material thickness of 170 feet above existing ground (approximately 375 feet from the toe to the top of the landfill). Based on an average of 300,000 cubic yards per year, the landfill could serve for approximately twelve years. If the annual material placement quantity is less, the landfill could serve for a longer time.

Ash will be placed in a terrace-and-bench configuration. Terraces will be a maximum of 60 feet in height with an approximate 3 horizontal to 1 vertical slope above and below each bench. Each terrace will be set back a minimum of 15 feet from the previous terrace to form a bench. The geotechnical engineer's stability calculations for SCA#2 allowed for slopes as steep as 2:1 with terraced benches every 60 feet in elevation. SCA has chosen to build with gentler slopes to maintain a conservative approach and reduce the potential for erosion.

SCA's ash includes a significant percentage of limestone which is added to the combustion process for SO₂ control. The SCA ash material has pozzolanic properties and tends to harden over time in the landfill, thus increasing mass stability and reducing the potential for leachate generation.

Initial landfill development consists of constructing a new sediment pond #018, the lower sediment trap #1, lower perimeter ash containment/conveyance ditches, storm water run-on prevention berms, and an access road turnaround for the trucks.

Periodic access roads will be constructed over time as part of landfill development. The upper sediment trap #2 and additional upper access routes will be constructed at a later time as the lower portion of the ash landfill nears that elevation.

Cover soil will be placed on finished ash surfaces and vegetation will be established to minimize erosion and percolation of rainfall into the ash. Cover soil will be placed as often as needed as part of routine reclamation operations. Seeding, fertilizing, and mulching of the cover soil will be performed in the Fall.

3.0 Geotechnical Evaluation

This section presents the results of a geotechnical evaluation completed by Professional Service Industries, Inc. (PSI) in April 2012. The purpose of the geotechnical evaluation was to

- characterize the subsurface profile of the site,
- evaluate the global and local slope stability of the proposed ash landfill,
- evaluate existing groundwater conditions and
- provide geotechnical recommendations regarding erosion control and construction considerations for the proposed ash landfill.

A summary of findings from the geotechnical report is included here. For more information we recommend a review of the full report (See Appendix C).

3.1 Site Description

The SCA #2 Ash Landfill encompasses approximately 34 acres in a small side canyon with existing elevations ranging from approximately 6400 to 6775. The site is underlain by colluvial and alluvial deposits. The surface includes vegetated areas as well as gravel, rock and boulders with steeper areas showing significant rock outcroppings.

3.2 Field Investigation

Two borings were completed at the proposed site. B-1 was completed to approximately 50 feet near the bottom (west) of the proposed fill. A permanent monitor well (MW8) was installed in the borehole to observe groundwater. B-2 was drilled to a depth of 33 ½ feet near the upper east area of the proposed site. Samples and boring characteristics were analyzed from each bore hole.

Four exploratory test pits were excavated to observe the near-surface soil conditions and depth to the bedrock.

PSI conducted Refraction Microtremor (ReMi) testing along three profile line arrays within the proposed site. This testing uses standard seismic refraction equipment. The waves measured were used to assist in differentiating between the overburden soil deposits and underlying bedrock. This assisted in determining approximate depth to bedrock at various locations across the site in between borings and test pits.

3.3 Laboratory Testing

Laboratory tests were completed on samples of soil and the SCA ash material to evaluate physical and engineering properties. Tests included direct shear, unconfined compressive strength, moisture-density relationship, and sieve analysis. A summary of the lab test results is shown on the following table.

Material Description	Water Content (%)	Maximum Dry Density (pcf)	Optimum Moisture Content (%)	Internal Friction Angle (Φ)	Gradation		
					Gravel (%)	Sand (%)	Silt/Clay (%)
Sandy Silt (ML)	9	-	-	-	13	32	55
Silty sand with gravel (SM)	5-7	-	-	-	26-35	32-38	33-38
Silty gravel with sand (GM) / (GP-GM)	2-5	-	-	-	40-76	15-30	9-31
Bulk combined ash sample from stockpile	-	88	24	32	2	50	48

3.3.1 Strength Tests

Given the cohesive strength developed in the compacted ash due to the pozzolanic properties of the ash, unconfined compressive strength tests were performed on three moisture conditioned cylinder samples. After drying, the samples were broken and the unconfined compressive strength of the ash material was found to be in the range of 5,760 - 6,910 psf. Effective Shear Strengths and Unit Weights of the different soils were determined as follows:

Description of Soil	Unit Weight of Soil, pcf		Effective Shear Strength	
	Moist	Saturated	C' (psf)	ϕ'
Ash	80	85	800	32
Silty gravel with sand (SM) (GM)	120	125	0	34
Gravel with silt, sand and cobbles (GP-GM)	140	145	0	38
Shale bedrock	150	155	25,000	0

3.4 Subsurface Conditions

The subsurface soil and bedrock observed generally consist of alluvial and colluvial materials (silty sands with gravel and silty gravel with sands) underlain by lean clays and sandy silt with cobbles and boulders. The soils are underlain by a relatively impervious layer of shale bedrock. The depth to the shale bedrock varied from approximately 14 to 50 feet below existing grade. Standard Penetration resistance, N-Values, ranged from approximately 32 to greater than 50 blows per foot in the overburden soils and greater than 50 blows per foot in the shale bedrock.

3.5 Groundwater

Groundwater was encountered in boring B-1 at a depth of approximately 20 feet below existing grades. Groundwater was not observed in boring B-2 or the exploratory excavations during the drilling/excavation operations. Groundwater is expected to remain 10 feet or more below the ground surface in the vicinity of the landfill and not anticipated to come into contact with any ash materials. Similarly, the groundwater is expected to remain perched atop the shale bedrock as it moves in a general northeast to southwest direction.

SCA has conducted groundwater sampling and analysis at the monitor well MW-8 set by PSI in boring B-1 (Approximate Latitude 39° 32' 18" North and Longitude 110° 23' 04" West.) This sampling and analysis occurred between January 31, 2012 and January 29, 2013. Results of the analysis are included in Appendix A. These results represent the pre-construction or baseline conditions for groundwater in the area. The analysis shows groundwater high in TDS and many of the Cations and Anions. Generally, these results are common for groundwater conditions in contact with the Mancos Shale formations.

SCA would have preferred to install an up-gradient monitoring well for the purpose of monitoring groundwater conditions prior to reaching the landfill area. However, since this site was selected due to its location at the head of the small side canyon (to reduce the potential for storm water and near surface groundwater) the uphill cliff topography of the site also does not allow for access to an up-gradient location. The lack of groundwater observed in B-2 near the upper portion of the landfill area supports the expectations for little to no groundwater at a higher

elevation. Access routes on the top of the mountain are a considerable distance away from the area and not likely to be representative of the groundwater reaching this area.

Given that the areas above the landfill area were not accessible, SCA would like to request a variance from the traditional up-gradient well or source.

3.6 Stability Analysis

Ash material placement at the SCA #2 Ash Landfill will be accomplished in a similar manner to the SCA #1 ash landfill. Ash will be placed above the existing alluvium/colluvium slopes in lifts, moisture conditioned and compacted. Based on the existing site topography, subsurface evaluation, geophysical study (ReMi), site reconnaissance and other information from available geologic maps, cross sections were developed for use in the slope stability analyses. Various cross section options were evaluated to model long term global stability of the overall landfill design, the intermediate stability during construction and to evaluate the local shorter term stability of the ash benches that will be used throughout the construction phases of the landfill.

The PSI Geotechnical Report (Appendix C) provides substantial detail and explanation of the modeling and calculations performed for various conditions. A summary of the results of these calculations is outlined below:

Global Long Term Stability Analyses (a minimum factor of safety of 1.2 is recommended)

Description	Geotech Cross Section	Method	Factor of Safety
Global Stability block failure mode (static)	E-E	Simplified Janbu	2.9
Global Stability block failure mode (pseudo-static)	E-E	Simplified Janbu	2.4
Global Stability circular failure mode (static)	E-E	Modified Bishop	3.0
Global Stability block circular mode (static)	E-E	Modified Bishop	2.5

Intermediate Stability Analysis (a minimum factor of safety of 1.2 is recommended)

Description	Geotech Cross Section	Method	Factor of Safety
Intermediate Stability block failure mode (static)	Intermediate Section 1	Simplified Janbu	3.5
Intermediate Stability block failure mode (pseudo-static)	Intermediate Section 1	Simplified Janbu	2.7
Intermediate Stability block failure mode (static)	Intermediate Section 2	Simplified Janbu	3.1
Intermediate Stability block failure mode (pseudo-static)	Intermediate Section 2	Simplified Janbu	2.5

Short Term Stability Analysis (Ash benches)

(Minimum factors of safety of 1.5 static and 1.2 pseudo-static conditions are recommended)

Description	Cross Section Slope (Ash Bench)	Bench Height (ft)	Method	Factor of Safety
Short term stability circular failure mode (static)	2H:1V	60	Modified Bishop	2.1
Short term stability circular failure mode (pseudo-static)	2H:1V	60	Modified Bishop	1.8

3.7 Design Parameters

After reviewing the recommendations from the PSI Geotechnical Engineering Report, SCA has determined the following design parameters for the SCA #2 Ash Landfill:

- 3H:1V slope on the face of the landfill
- Benches/Terraces 15 feet wide at a maximum vertical spacing of 60 feet
- Drainage Collection ditches on each bench/terrace with the ditch profile slope generally in the range of 1-2%. Drainage will be directed to perimeter collection ditches, through erosion control BMP's and sediment traps and then into a clay-lined sediment pond.

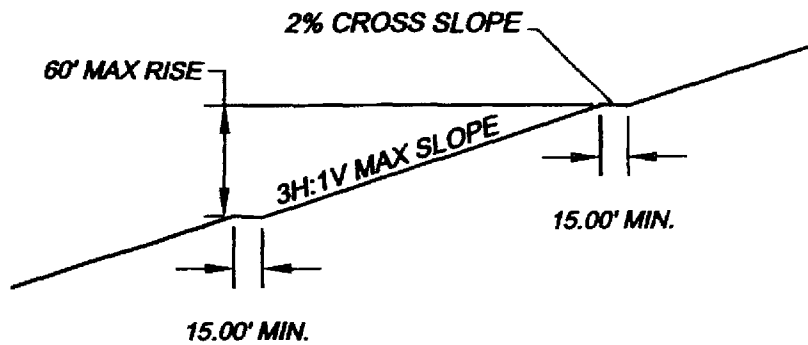

TYPICAL FILL SECTION

In an effort to be more conservative and provide for a greater factor of safety in the design, SCA is using a design slope of 3H:1V on the face of the landfill instead of the steeper 2H:1V slope that the geotechnical engineer has determined to be allowable. SCA recognizes the variability that may occur in construction and has chosen this gentler slope to provide flexibility and a level of tolerance in the construction conditions. A construction tolerance will allow segments with slopes up to 2.5H:1V without re-grading, but all areas that inadvertently end up steeper than 2H:1V will be re-graded.

SCA also expects that this gentler design slope will give the project a greater stability, reduced risk of erosive conditions and improved conditions for reclamation.

3.8 Settlement Analysis

The placement of ash on the alluvium is likely to cause settlement of the alluvium. The geotechnical analysis of the site indicates that, given the granular nature of the overburden and ash materials, consolidation settlement and secondary compression have been determined to be negligible. Immediate settlement is calculated with the soil behaving as a linear elastic material. Settlement is estimated to be on the order of 6 to 8 inches. Settlement of the material should occur relatively quickly after initial placement. Thus the majority of expected settlement should occur during construction as the ash materials are placed.

The magnitude of expected settlement (even if it was double the estimated amount) is tolerable during construction and operation of the SCA #2 Ash Landfill.

3.9 Summary of Geotechnical Conclusions

The conclusions of the PSI geotechnical evaluation are summarized in the following paragraphs.

Water: While ground water was not observed in Boring B-2 (upper east slope) or in any of the test pits, ground water was observed in Boring B-1 at the lower west end of the site. No surface waters were present at the site or within the near proximity of the site. The granular surface soils (ranging from approximately 14 to 50 feet thick) on top of the relatively impervious shale bedrock will provide an adequately porous layer to convey any ground water that does migrate under the proposed ash landfill. Any migrating ground water is expected to move in a general northeast to southwest direction atop the shale bedrock and at least 10 feet below the ground surface in the vicinity of the landfill and not come into contact with the ash materials.

Leachate Evaluation: PSI recommends placement of a 6-inch thick low permeability soil cap on top of the completed landfill with a native soil cover above that for re-vegetation. Surface water should be controlled to reduce the potential for erosion or ponding and observed erosion conditions should be repaired. Providing these recommendations are followed, PSI anticipates that the risk of water percolating through the ash material and into the groundwater is minimal.

Structural Stability: PSI conducted several structural stability analyses for the proposed landfill in various possible configurations ranging from bench heights of 30 ft. and cross slope section of 1.5H:1V up to a bench height of 60 feet and cross slope section of 2H:1V. All of the configurations modeled indicated short term and long term safety factors greater than the minimums recommended per ASTM E 2277-03 "Standard Guide for Design and Construction of Coal Ash Structural Fills" and also in accordance with the guidelines presented in USACE Manual EM 1110-2-1902 "Slope Stability".

Settlement: PSI recommends that ash materials be placed in maximum 12-inch lifts and with proper compaction; the expected settlement occurring in this landfill will have minimal impact.

Site Suitability: Based on the results and recommendations of their study, PSI is of the opinion that the site of the proposed SCA#2 ash landfill is suitable from a geotechnical engineering perspective.

4.0 Soil Cover Design and Reclamation

SCA has gained successful reclamation experience over the past 20 years and benefitted from the collective experience of the Utah coal mining community. SCA's proposed soil cover is based on this experience and is designed to both minimize water percolation in contact with the ash materials and to promote successful re-vegetation and erosion control. The following principles have influenced this design:

- Precipitation in the area ranges from 10 inches to 20 inches per year
- Evapotranspiration in the area can range from 20 inches to 35 inches per year
- Seeding with a mixture of properly selected species can establish a good vegetative cover to reduce erosion, reduce weeds, maintain natural conditions and extract water from the soil cover layer.
- Mixing a weed free straw or hay mulch along with fertilizer into the upper soil cover layer provides added nutrients in the soil cover without making it immediately available for weed growth.
- Placement of the soil cover in a roughened state can reduce erosion gullies by capturing precipitation in small pockets rather than allowing it to run down the slope. These pockets are also effective at assisting initial vegetation growth.
- A layer of low permeability soil beneath the vegetative soil cover can reduce the potential for soil moisture to come into contact with the ash materials

Given the principles above, SCA proposes the following soil cover design:

- Cap the landfill with a 6 to 8-inch layer import soil material. SCA has developed a practice at the SCA #1 Ash Landfill for placing and compacting this soil cap and will continue to follow this practice on the SCA #2 Ash Landfill. This includes importing clean soil material (2-inch minus with relatively high percent fines). Place and spread this

material across the surface of the slope, moisture condition and compact with a small dozer, making two passes.

- Place a native soil layer for vegetative growth (average 18 to 24-inch loose thickness)
 - The proposed native soil will be tested to confirm appropriate fertilizer and mulch amendments. Given the experience with native soils in this area, it is expected that soil amendments may include something like the following:
 - Spread fertilizer over the soil cover at a rate of up to 200 lb./acre 16-16-8 fertilizer (slow release) or equivalent
 - Depending on the organic content of the native soil, SCA may choose to spread up to 1.5 ton per acre of certified weed free straw mulch.
 - Mix the above noted fertilizer and mulch into the top 12-18 inches of soil utilizing any efficient and effective method (some options include scarifying, plowing, track hoe pocketing, etc.) and
 - Leave the slope surface in a roughened condition to reduce erosion potential (typical 4"-8" deep pockets)
- Seed with reclamation seed mix currently being used on SCA's Sunnyside properties, hydro-seeded with 1.5 tons per acre wood fiber mulch and tackifier.

5.0 Leachate Potential

Extensive modeling for and evaluation of leachate potential has been prepared in connection with the design of the SCA #1 Ash Landfill located a short distance to the west / north west of this site. (For more information, please refer to Appendix D which includes the modeling reports of the SCA #1 Ash Landfill). The SCA #1 Ash Landfill was designed with a 16" soil cover and no base liner. Surface water is directed around and off of the landfill and contained in lined sedimentation ponds. The different phases of the SCA #1 Ash Landfill have been in operation and / or closure during the past 20 years. Regular monitoring of ground water and surface water in the area confirms the results of the modeling which indicated no significant impacts to ground water were expected.

Given the proposed soil cover for the SCA #2 Ash Landfill described above, the pozzolanic properties and low hydraulic conductivity of the ash, the dry conditions at the selected site, the proposed surface water controls and the proposed lined sediment pond: the proposed design of the SCA #2 Ash Landfill, with no base liner, 6-8 inches of compacted soil cap and 18-24 inches of vegetated native soil cover, will not result in groundwater quality impacts beyond limits established by the State of Utah. The potential for leachate discharge to occur during the active and post-closure phases of the SCA #2 Ash Landfill is negligible.

5.1 Sediment Pond #018 Liner

Sediment Pond #018 will be lined with a low-permeability barrier layer to minimize infiltration of ash-contact runoff which is captured in the pond. The proposed liner design involves either a native clay layer or soil/bentonite mixture.

A native clay material liner would consist of screened import material (2-inch minus), spread and compacted in place. The liner would be 12 inches thick, compacted in two 6-inch lifts to 95% with a resultant hydraulic conductivity less than or equal to 1×10^{-5} cm/s.

A soil / bentonite mixture would consist of screened native soil (2-inch minus) and granular bentonite (minus-40 mesh) blended in specific proportions (minimum 6 percent – dry weight basis), moisture conditioned to above-optimum moisture content, and spread and compacted in place. The liner would be 8 inches thick, compacted to 95% with a resultant hydraulic conductivity less than or equal to 1×10^{-5} cm/s.

Given the sediment traps proposed up from the Sediment Pond #018, it is expected that the sediment accumulation in #018 will be significantly reduced and regular sediment cleaning will occur more in the sediment traps and less in #018. Nonetheless a 6-inch protective layer of native soils (screened material 2-inch minus) will be placed on top of the liner with detecta tape placed at 3 to 5 foot intervals between the liner and the protective layer.

5.1.1 Proposed Hydraulic Conductivity Testing

Prior to placing the pond liner, construction methods will be reviewed with a geotechnical lab and simulated with the actual material to be used for the liner (either the actual native clay material or the proposed mixture of bentonite/soil). It is proposed that hydraulic conductivity of the liner be determined by preparing two samples using the proposed material and methods and performing falling head conductivity tests in accordance with ASTM D 5084 on the samples. Upon verification that the proposed material and methods will meet permeability requirements, the construction would proceed with field tests to verify compaction.

6.0 Surface Water Controls

This section presents the analysis and design of the surface water control features for the SCA #2 Ash Landfill. The governing principals behind the surface water controls for this landfill are to collect and divert runoff via terrace ditches to the perimeter collection ditches. This water is detained briefly in sediment traps to slow the flow rate and drop sediments prior to reaching the lined sediment pond #018. Straw bales or other bmp's will be placed periodically in the perimeter collection ditch to further assist in slowing the flow velocity and reducing the potential erosion. SCA has submitted a permit application package to the Utah State Engineer for approval to build Sediment Pond #018 (See Appendix E).

Runoff calculations are based on the concept that the ash terraces will be covered as described above on a periodic basis such that the entire ash landfill is not exposed at the same time. This will allow the re-vegetation efforts to establish a reasonable ground cover and minimize runoff and erosion for the project.

6.1 Existing Surface Water Features

As previously stated, the location for the SCA #2 Ash Landfill was selected in part due to the absence of water sources in the area. This site is not located in a 100 year flood plain and only ephemeral surface water features exist in the near vicinity. The site is located in the upper headwaters area of Icelander Creek. Icelander Creek is normally dry near the site but often has

extended seasonal flows below Whitmore Springs located approximately 1.5 miles to the west / northwest of the site. Water Canyon is located approximately 0.5 miles to the south of the site and typically only sees storm related or snow melt related runoff. Grassy Trail Creek is located approximately 0.8 miles to the north / northwest and usually experiences flow during seasonal runoff conditions and releases from the upstream dam.

6.2 Hydrologic Data

The rainfall point values for the Sunnyside and East Carbon, Utah area were obtained from the NOAA Atlas 14, Volume 1, Version 5. The 24-hour rainfall values used are 1.99 inches for the 10-year event and 2.83 inches for the 100-year event.

Runoff was estimated using the Rational method and hand computations. Assuming Type I antecedent moisture conditions for the site, the runoff coefficient was estimated at 0.65 for exposed ash conditions, 0.25 for surfaces that have been recently covered with soil and roughened, and 0.15 for surfaces that have been re-vegetated in a roughened condition.

The direct tributary drainage area to Sedimentation Pond #018 is approximately 55 acres. The designed sediment traps 1 and 2 together with straw bales and other bmp's will slow the peak flow velocities in the ditches and reduce the sediment load, but overall, the total volume of water delivered to #018 is the same. These sediment traps have been factored into the hydrologic modeling.

Pond and sediment trap design details, watershed boundaries, flow paths, pond connectivity, diversions, ditches, and calculations are shown in the Appendix B to this report and the accompanying drawing package (Appendix F).

Runoff from most areas outside the landfill footprint will generally be diverted away from the sediment pond using diversion berms and ditches on the landfill perimeter.

6.3 Design Assumptions

When the SCA #2 Ash Landfill development is in progress, the tributary drainage area to the sedimentation pond will consist of a combination of existing ground in undeveloped areas, exposed ash on active terraces and benches of the active cell, and cover soil on closed benches. Existing ground in undeveloped areas of the site consists of a coarse alluvium in a relatively dry condition. Runoff from these areas will generally either be diverted away from the landfill or be collected with the landfill runoff and flow to the sediment pond.

Ash surfaces in the active cell tend to be in a somewhat dry condition after exposure to the evaporative conditions typical of the area. Benches in the cell will be sloped inward to prevent runoff from cascading down the terrace faces as an erosion-prevention measure. Runoff from the top of the terrace will drain to perimeter ditches or terraces and be conveyed to the sediment traps and pond. Cover soil on closed portions of the landfill will also tend to be in a relatively dry condition, and will be sloped and roughened as described in the reclamation section above.

As expected, runoff computations indicate that the greatest runoff volume is generated from exposed ash surfaces. In order to produce a conservative pond design volume (on the side of oversizing), the pond was design to contain the runoff volume projected and then the two main sediment traps were added. While it is anticipated that the sediment traps will remain open and drain slowly through the discharge pipe, it is possible to temporarily close the discharge pipe valve and hold the storm water to avoid a discharge from sediment pond #018. The UPDES permit will allow a discharge from #018 as long as the discharge is tested and meets the required water quality standards.

6.4 Hydrologic Modeling Analysis Results

Based upon computations using the Rational method, the 100-year 24-hour event will produce approximately 2.3 acre feet of runoff in a final reclaimed condition. The 10-year 24-hour event will produce between approximately 1.0 and 3.0 acre feet, depending on the condition of the landfill construction at the time of the storm (amount of the landfill constructed, extent of exposed ash surface, sediment traps, etc.). Calculation summaries are included in Appendix B.

Sediment Pond #018 is designed with a capacity of approximately 2.5 acre feet, below the 18" overflow discharge standpipe. Discharge capacity through the standpipe is as much as 13 cfs. While it is possible to envision two major storms occurring in a short time period (with a combined precipitation greater than the design storm), it is expected that there will be no discharge during most years.

Sediment Trap #1 is designed with a capacity of approximately 1.6 acre feet below the 24" overflow discharge standpipe. Discharge capacity through the standpipe is as much as 18 cfs, but it is expected that most storms will be smaller than 1.6 acre feet and will therefore simply drain this sediment trap through the 2" drain pipe at flow rates less than 0.3 cfs. Discharge from Sediment Trap #1 will flow directly to Sediment Pond #018.

Sediment Trap #2 is designed with a capacity of approximately 1.4 acre feet below the overflow discharge spillway ditch. Discharge capacity over the spillway can be as much as 15 cfs, but it is expected that most storms will be smaller than 1.4 acre feet and will therefore simply drain this sediment trap through the 2" drain pipe at flow rates less than 0.3 cfs. Discharge from the Sediment Trap #2 drain pipe will flow to a terrace ditch and into the south perimeter collection ditch which will flow to Sediment Trap #1 and then to Sediment Pond #018. If Sediment Trap #2 fills and discharges through the overflow spillway, it will follow ditches on SCA property into SCA's Borrow Area Pond #016 which, if it ever discharges, would end up into Sediment Trap #1 and then Sediment Pond #018.

6.5 Ditch Conveyance and Erosion Control

This section discusses erosion control for runoff control ditches at the SCA #2 Ash Landfill. Ditches flowing across the terraces and around the perimeter of the landfill will not generally be lined. The minimum ditch grade at the landfill is approximately 1 percent—there is little chance that excess ponding will occur in any ditches. The ponding area of the sediment pond #018 will be 100-percent lined, as described above. Ash contact runoff may wet the soil in the ditch invert, but will tend to quickly evaporate in the arid climate rather than infiltrate.

Flow velocities in the terrace ditches will generally be high enough that little sediment deposition will occur. Therefore any ash which may erode from the landfill will be deposited in the sediment traps or the lined sediment pond. Ash and sediment will be routinely excavated from the traps and pond and placed into the active ash cell.

The north and south perimeter ditches are sloped much greater than terrace ditches. They will have periodic bmp's (such as straw bales, silt fences or other check dams) to reduce the risk of serious bed erosion in the ditch. If significant amounts of sediment build up behind the bmp's, maintenance will be required to ensure the continued functionality of the ditch and bmp.

As an alternate to bmp's described above, SCA may determine that it is more efficient to place rock armoring in the ditches to control erosion. Gravel and cobbles obtained from screening cover soil can be placed along the ditch invert. Some fines will initially wash away (to the sedimentation trap), leaving a natural graded armor layer. SCA may also choose to install additional small sediment traps, or other bmp's, at the site to manage flow rates.

7.0 Construction QA / QC Plan

It is in the best interest of SCA to ensure proper construction of the sediment pond, sediment traps, storm water bmp's, ditches, terraces, ash placement and reclamation cover. SCA will oversee its contractors and be responsible for requiring proven construction means and methods from them. Verification of proper material placement and compaction will include a variety of testing:

A. Sediment Pond and Sediment Traps

- a. All sites to receive fill material placement shall be Cleared and Grubbed. This shall include removal of all organic matter from the site. Approximately 12" of topsoil, roots, and other organic matter shall be removed. Topsoil should be salvaged and placed on the final surface prior to re-vegetation. Large organic matter may be chopped and spread across re-vegetation areas.

b. Import material for dike construction or clay liner

- i. A minimum of two gradation sieve analyses shall be obtained from the import source. Random spot observation during delivery and spreading shall verify that no organic or oversized material is received.
- ii. A minimum of two modified proctor tests shall be obtained from the import source. Proctor tests shall be performed on the actual material to be provided and shall occur no more than 30 days prior to material delivery. On site compaction shall be compared to the average of the two proctors.

c. Compaction

- i. Moisture conditioning shall be performed to bring fill materials within +/- 2% of optimum conditions as determined for the material being placed.
- ii. Dike core construction shall occur in 8"-12" lifts and include compaction by heavy construction equipment common to the area. A minimum of 95% compaction shall be required. A minimum of two compaction density tests shall be performed on each lift prior to placing the subsequent lift.
- iii. Clay liner construction shall occur in two 6" lifts and include compaction by heavy construction equipment common to the area. A minimum of 95% compaction (or greater if required by geotechnical lab hydraulic conductivity tests for the material being placed) shall be required. A minimum of one compaction density tests per 3000 sqft shall be performed on each lift prior to placing the subsequent lift. (It is anticipated that approximately 13-15 in place tests will be performed for the clay liner on Pond 018.)
- iv. Cover soil placed over the clay liner shall occur in one 6" lift and include compaction by heavy construction equipment common to the area. A minimum of 90% compaction shall be required. A minimum of three compaction density tests shall be performed on the cover material placed on Pond 018.

- v. Additional fill material placed over the dike to achieve design slopes shall occur in maximum 12-16" lifts and include compaction by heavy construction equipment common to the area. A minimum of 90% compaction shall be required. A minimum of one compaction density tests shall be performed on each lift prior to placing the subsequent lift. No compaction shall be required for topsoils placed on the surface.

B. Ash Material Placement

- a. All sites to receive ash fill material placement shall be cleared of all vegetation. Topsoil (if any) should be salvaged and placed on the final surface prior to re-vegetation. Large organic matter may be chopped and spread across re-vegetation areas.
- b. SCA has developed a program for ash material placement that includes spreading ash material in 6"-8" lifts, moisture conditioning and compacted by a grader with a hydraulic compaction roller. This is done with at least two passes.
- c. SCA has designed the SCA#2 Ash Landfill with the intent that the outer slope will average 3H:1V. Periodic survey measurement will occur on each terrace/lift. If any significant portions of the lift have a slope steeper than 2.5H:1V, they shall be re-graded.
- d. SCA has designed the SCA#2 Ash Landfill with the intent that the elevation change from one terrace to the next shall not exceed 60 feet, and that the profile slope for the terrace ditch shall average 1%-2% slope. Terrace benches are intended to have a minimum 2% cross slope into the hill to keep storm water from spilling over the bench. Periodic survey measurement will occur on each terrace/lift. If any significant portions of the terrace are higher than 60 feet, they shall be re-graded. If any significant portions of the terrace ditches are less than 0.5% or steeper than 3.5% slope, they shall be re-graded. (Perimeter ditches are designed with steeper slopes and shall be constructed on native soil – not over ash material- and include regular bmp's for velocity control).

C. Reclamation Soil Cover

- a. Either import or native soils may be used for cover material, provided they meet the intended purpose.
- b. A 6" – 8" soil cap (2" minus with relatively high percent fines) shall be placed over the ash material. Compaction shall include two passes with the dozer. No in place density tests shall be required.
- c. An 18" – 24" loose layer of reclamation soil shall be placed over the soil cap and roughened in place. Tests for vegetative parameters will be performed for each material source to confirm the appropriate amount of fertilizer and mulch to be added.
- d. Random pothole verification shall be performed to observe the depth of soil placed. Approximately 3-4 potholes per lift shall be dug.

8.0 Operation / Maintenance Plan

SCA will operate and maintain the SCA #2 Ash Landfill in accordance with the requirements of the Groundwater Permit.

Closure will include covering and re-vegetation as described above. The SCA #2 Ash Landfill would be considered closed after the soil cover is complete and the landfill has been reseeded.

Post Closure monitoring will occur for 10 years following the point of closure and will include semi-annual inspections to observe the success of re-vegetation, check for erosion problems, and sample the monitoring well MW-8. Maintenance of the site may require attention to re-vegetation or erosion needs. Water monitoring will verify that groundwater conditions are still within protection limits set in the Groundwater Permit. The Post Closure period would be considered complete when ten years following closure have past, re-vegetation efforts have resulted in conditions similar or better than the surrounding area, and surface soils are stabilized (erosion conditions do not present a risk of exposing the ash material).

9.0 Contingency and Corrective Action Plan

SCA will operate and maintain and monitor the SCA #2 Ash Landfill in accordance with the Operation and Maintenance plan described in Section 7.0 throughout the operational, closure and post closure periods.

During these time periods, it is possible that conditions could arise which require corrective action. SCA has developed a plan to address the potential conditions as follows:

- Erosion Gullies – It is possible that erosion gullies could develop on the face of the landfill or in the drainage channels. The likely cause of this condition is from a large storm event or many smaller events over time. Corrective action would be site specific but would focus on controlling surface water runoff, slowing the velocity, redirecting to a stable area and / or filling the gully and re-establishing vegetation.
- Slumping or mass movement of ash or other soil materials – Although the proposed slopes are more conservative than required by the geotechnical engineer, in the event of mass movement, SCA would re-evaluate the stability of the slope in that area and re-grade as necessary to achieve a stable slope.
- Water Quality
 - Surface Water – The state UPDES permit will specify the required quality of surface water discharges from this site. SCA will monitor the UPDES point as required by the permit. In the event that discharges exceed the quality standards, SCA will evaluate and implement the best management practices needed to stay in compliance. Some options may include increased pond or sediment trap capacity; additional ponds, sediment traps or other bmp's; increased re-vegetation efforts to reduced sediment and runoff; etc.
 - Ground Water – SCA will monitor the groundwater quality at MW-8. Given the conditions of the site and the ash material, ground water impacts from the ash landfill are not likely. Nonetheless, if SCA experiences monitoring results that exceed the protection limits, it will take measures to verify the test results, determine the cause of the higher results and implement efforts to reduce potential impacts from the ash landfill (i.e. increased soil cap, additional water diversions, etc.).

SUNNYSIDE COGENERATION ASSOCIATES
SCA #2 ASH LANDFILL
 CONSTRUCTION DRAWINGS SUBMITTAL
 Carbon County, Utah

CONSTRUCTION PERMIT ISSUED BY
 Utah Department of Environmental Quality
 Utah Division of Water Quality

Date: 4 Sept-2014

Review Engineer: WJC

Director: [Signature]



Sheet Index

- SHEET 1 - TITLE SHEET & SHEET INDEX
- SHEET 2 - BOUNDARY SURVEY
- SHEET 3 - EXISTING SITE CONDITIONS
- SHEET 4 - ACCESS ROUTE PLAN
- SHEET 5 - PROPOSED LANDFILL LAYOUT
- SHEET 6 - PROPOSED LANDFILL EARTHWORK CALCS
- SHEET 7 - OVERALL LANDFILL CROSS SECTIONS
- SHEET 8 - DRAINAGE PLAN
- SHEET 9 - SEDIMENT POND #018 DESIGN
- SHEET 9A - SEDIMENT POND #018 DESIGN EXISTING CONDITIONS
- SHEET 9B - SEDIMENT POND #018 DESIGN SURVEY CONTROL
- SHEET 9C - SEDIMENT POND #018 DESIGN CROSS SECTIONS
- SHEET 10 - SEDIMENT TRAP #1 DESIGN
- SHEET 10A - SEDIMENT TRAP #1 DESIGN EXISTING CONDITIONS
- SHEET 10B - SEDIMENT TRAP #1 DESIGN SURVEY CONTROL
- SHEET 10C - SEDIMENT TRAP #1 DESIGN CROSS SECTIONS
- SHEET 11 - SEDIMENT TRAP #2 DESIGN
- SHEET 11A - SEDIMENT TRAP #2 DESIGN EXISTING CONDITIONS
- SHEET 11B - SEDIMENT TRAP #2 DESIGN SURVEY CONTROL
- SHEET 11C - SEDIMENT TRAP #2 DESIGN CROSS SECTIONS
- SHEET 12 - LOWER ACCESS ROAD DESIGN

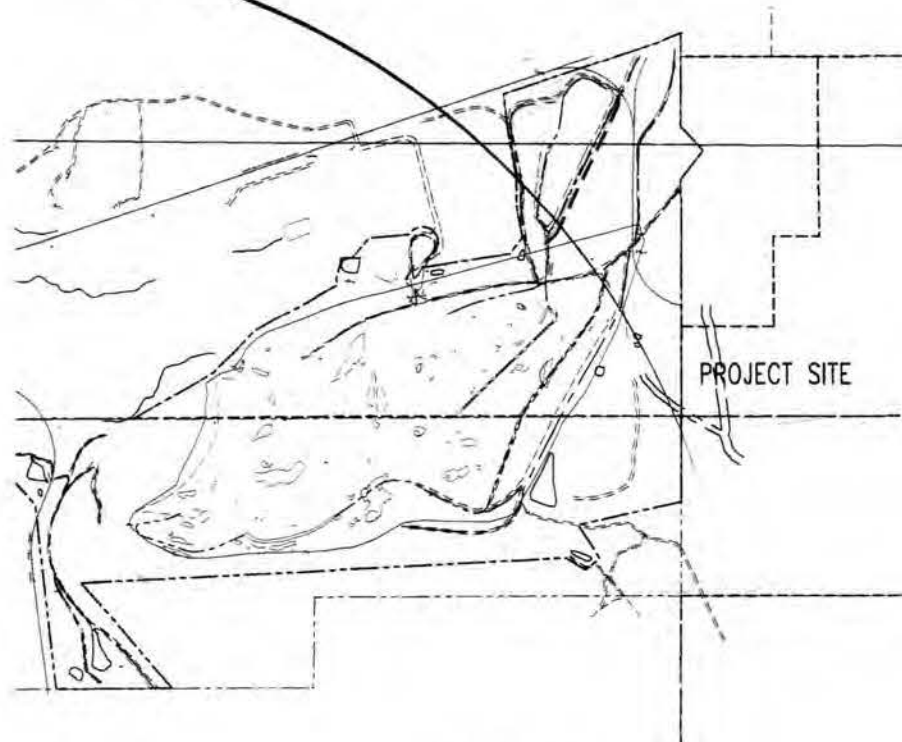
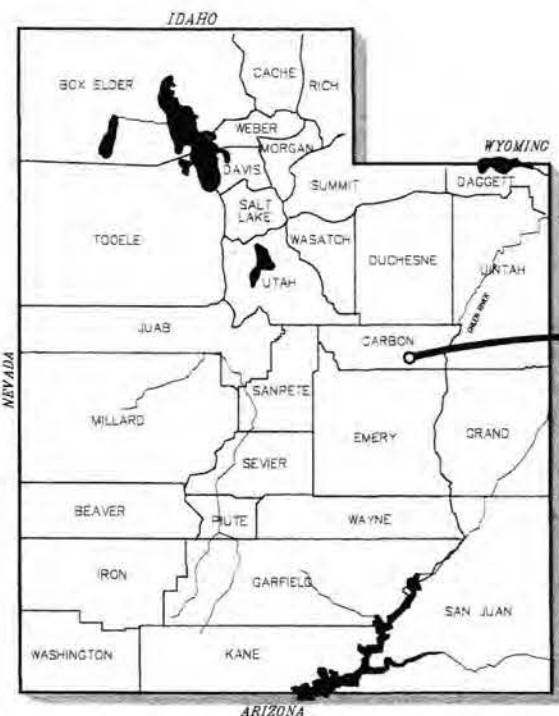

VICINITY MAP

LANDFILL DESIGN CHARACTERISTICS, INCLUDING SLOPE,
 TERRACE WIDTHS, ELEVATION BETWEEN TERRACES AND OTHER
 CONDITIONS ARE BASED ON REQUIREMENTS OUTLINED IN THE PSI
 GEOTECHNICAL STUDY DATED APRIL 6, 2012



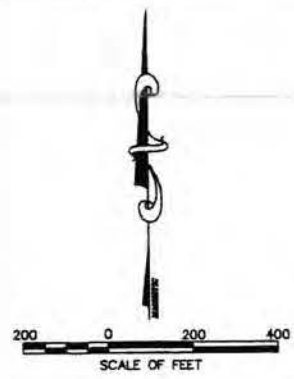
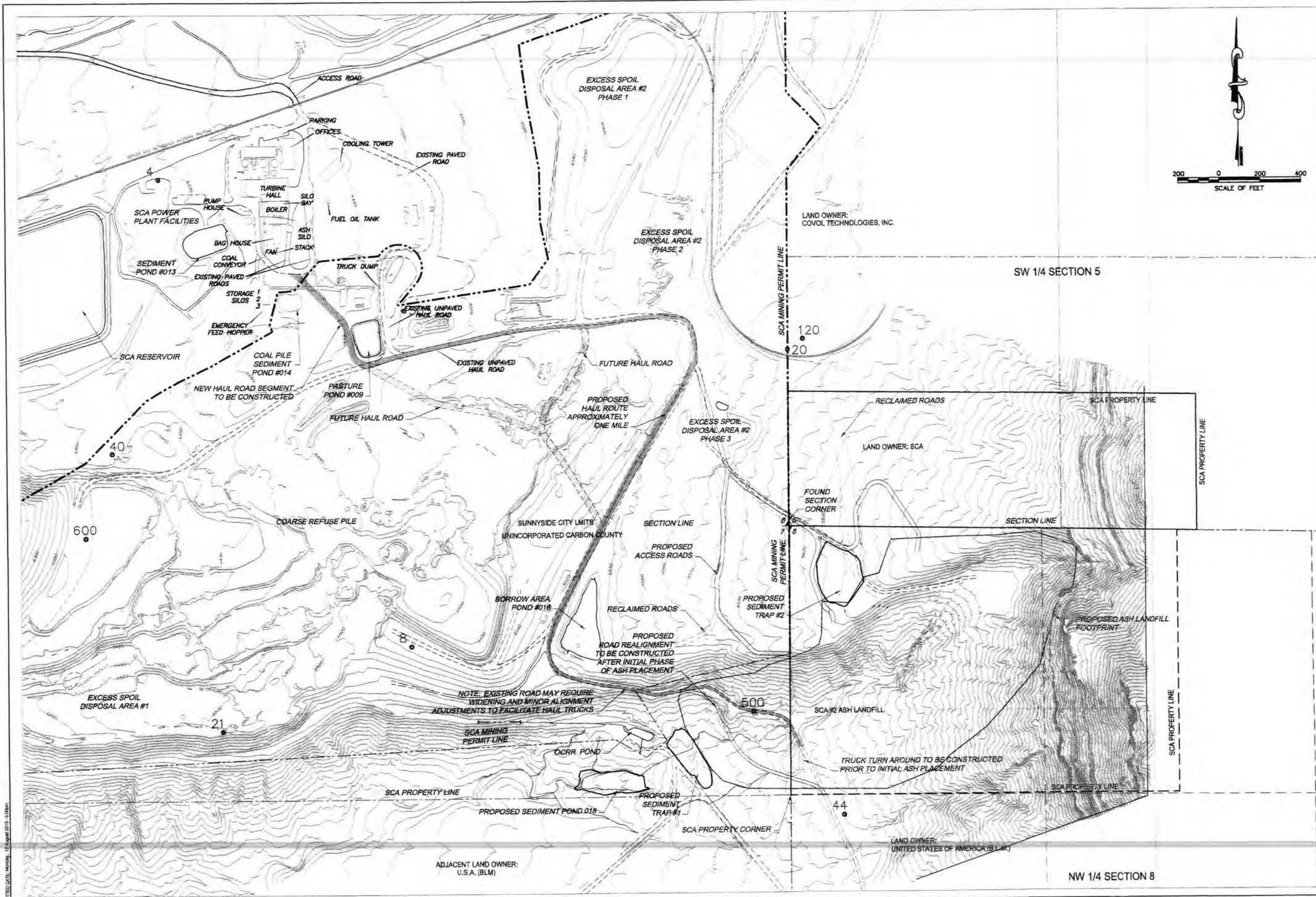

SUNNYSIDE COGENERATION ASSOC.
SCA #2 ASH LANDFILL CONSTRUCTION DRAWINGS
ACCESS ROUTE PLAN
 Carbon County, Utah

TWIN PEAKS
 Engineering & Land Surveying
 2204 NORTH 10300 EAST, SUITE 100, UTAH PARK, UT
 (801) 450-7511, (801) 438-0700 FAX

DATE:	AUGUST 2013
PLAT DATE:	12 August 2013
SHEET:	4
	12

PLOTTED DATE: MONDAY, 12 AUGUST 2013 10:50AM

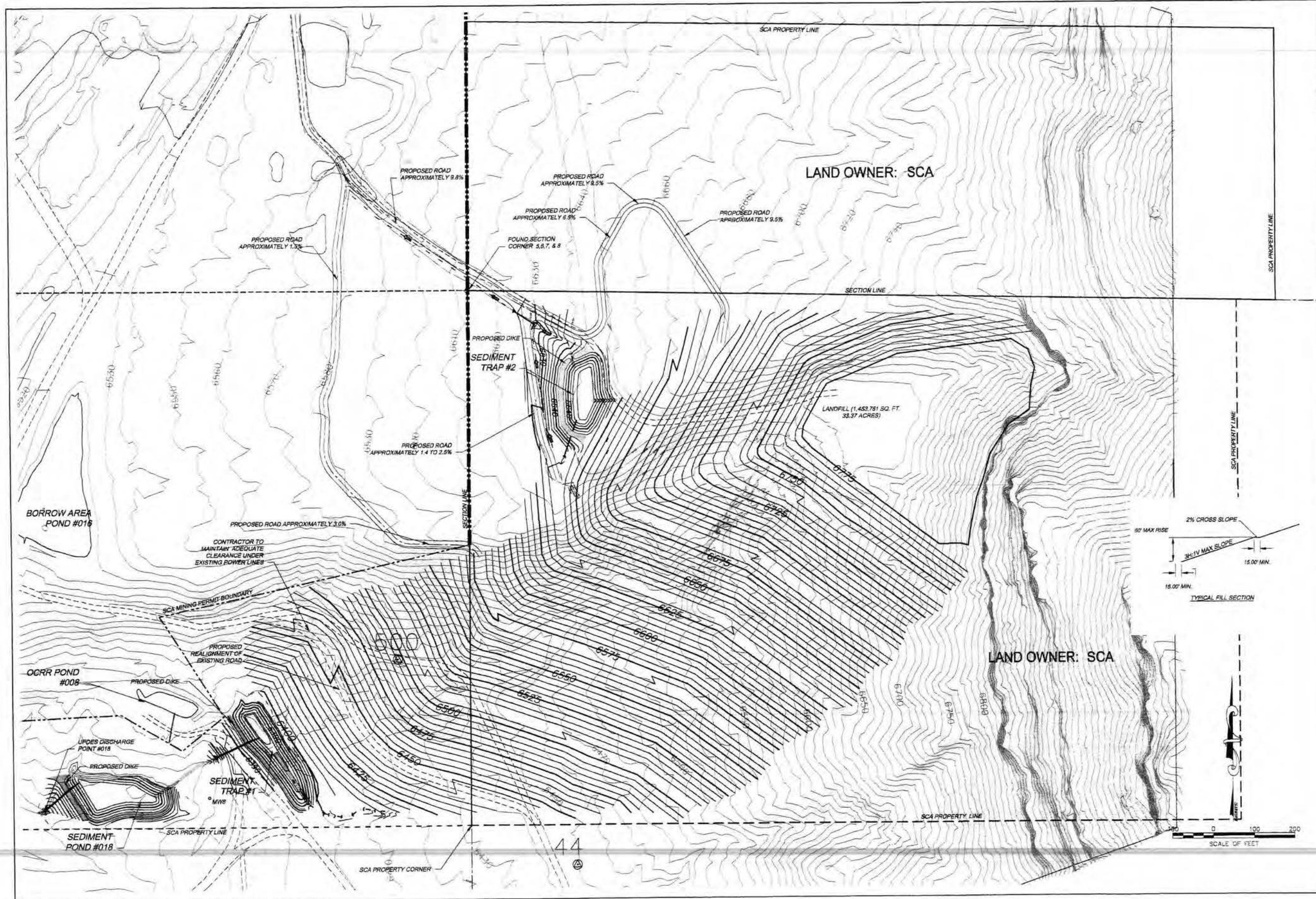

LAND OWNER: SCA

LAND OWNER: SCA

SUNNYSIDE COGENERATION ASSOC.
SCA #2 ASH LANDFILL CONSTRUCTION DRAWINGS
PROPOSED LANDFILL LAYOUT
 Carbon County, Utah

TWIN PEAKS
 Engineering & Land Surveying
 2764 NORTH 1440 EAST 111E, UTAH ROAD 5
 (801) 452-9511, (801) 438-0700 FAX

DATE:	NOV 2012
PLAT DATE:	17 March 2014
SHEET:	5
OF:	12

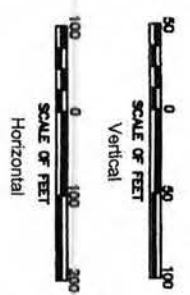
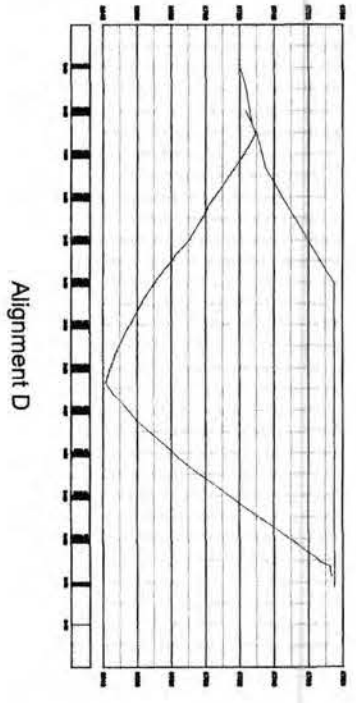
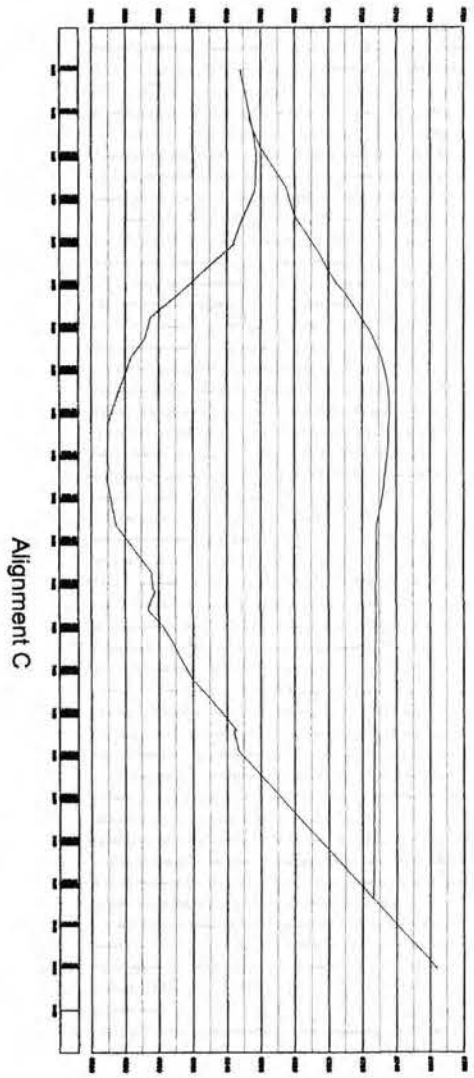
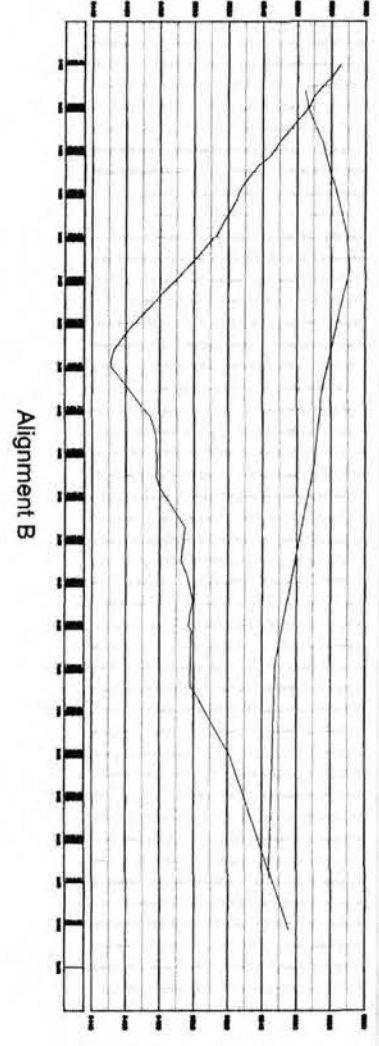
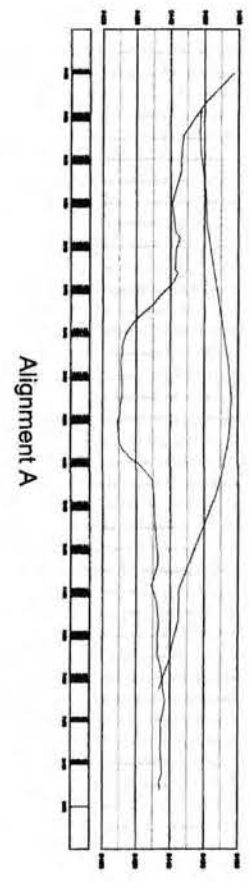
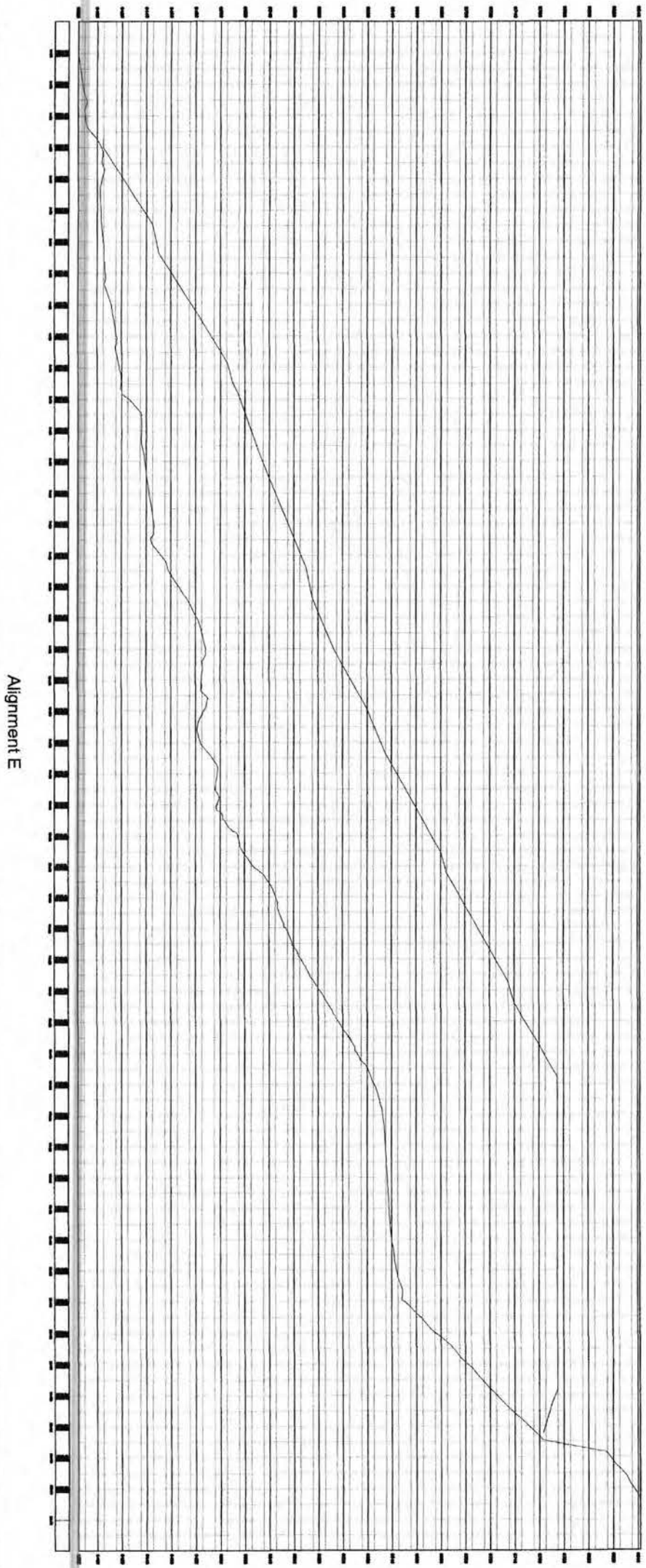

DATE PLOTTED
AUGUST 2013
PLOT DATE
12 August 2013

12

TWIN PEAKS
Engineering & Land Surveying
2264 NORTH 1450 EAST LEHI, UTAH 84043
(801) 450-3511, (801) 439-0700 FAX

SUNNYSIDE COGENERATION ASSOC.
SCA #2 ASH LANDFILL CONSTRUCTION DRAWINGS
CROSS SECTIONS
Carbon County, Utah

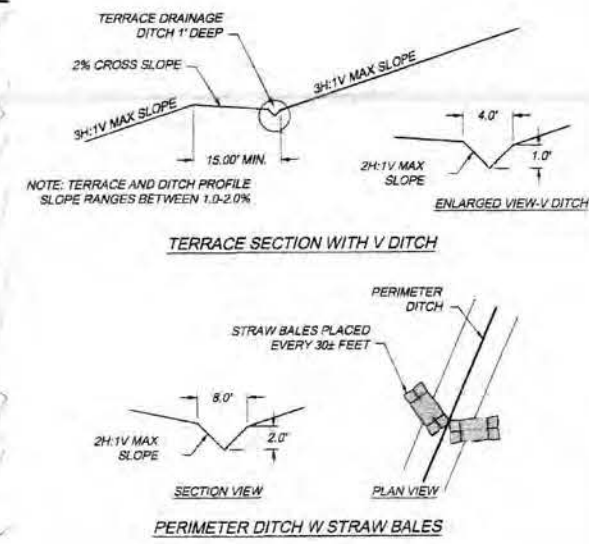
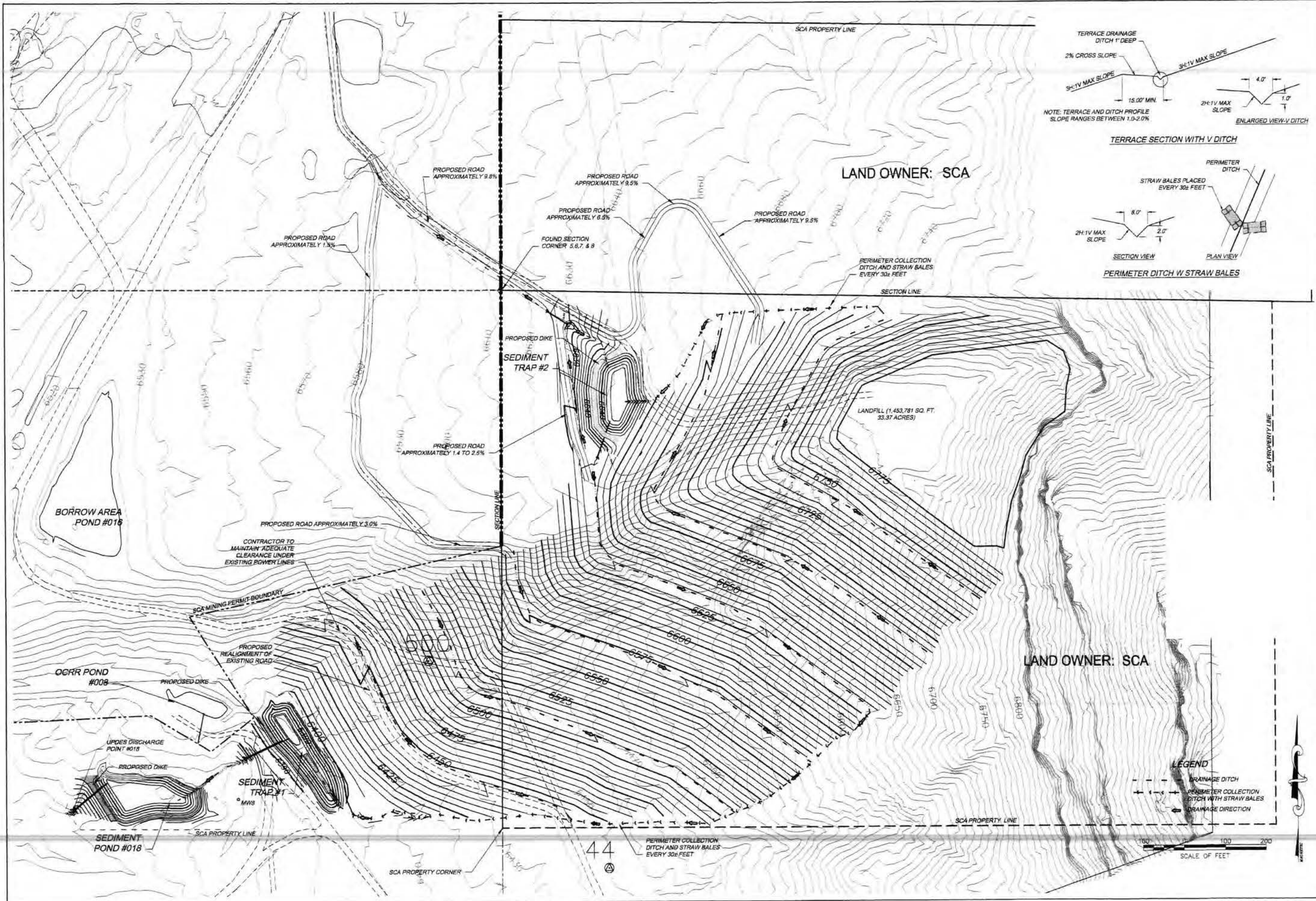

SUNNYSIDE COGENERATION ASSOC.
SCA #2 ASH LANDFILL CONSTRUCTION DRAWINGS
PROPOSED DRAINAGE PLAN
 Carbon County, Utah

TWIN PEAKS
 Engineering & Land Surveying
 2204 NORTH 1450 EAST LEBL, UTAH 84003
 (801) 450-3511 (R) 439-0700 FAX

DATE:	AUGUST 2013
DATE:	17 March 2014
SHEET:	8
	12

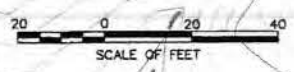
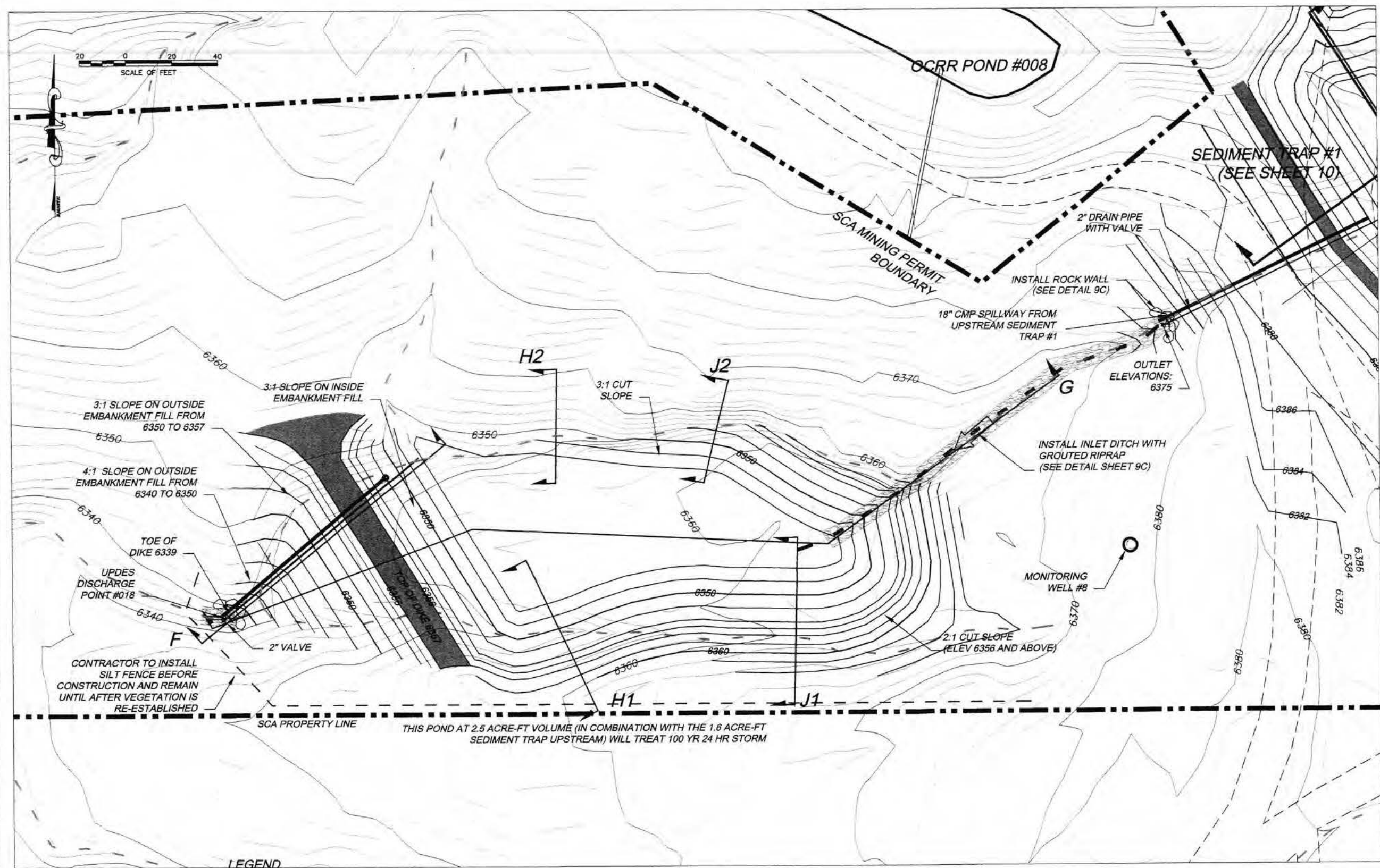

3:1 SLOPE ON OUTSIDE EMBANKMENT FILL FROM 6350 TO 6357
 3:1 SLOPE ON INSIDE EMBANKMENT FILL
 4:1 SLOPE ON OUTSIDE EMBANKMENT FILL FROM 6340 TO 6350
 TOE OF DIKE 6339
 UPDES DISCHARGE POINT #018
 2" VALVE
 CONTRACTOR TO INSTALL SILT FENCE BEFORE CONSTRUCTION AND REMAIN UNTIL AFTER VEGETATION IS RE-ESTABLISHED

OCRR POND #008
 SCA MINING PERMIT BOUNDARY
 2" DRAIN PIPE WITH VALVE
 INSTALL ROCK WALL (SEE DETAIL 9C)
 18" CMP SPILLWAY FROM UPSTREAM SEDIMENT TRAP #1
 OUTLET ELEVATIONS: 6375
 INSTALL INLET DITCH WITH GROUTED RIPRAP (SEE DETAIL SHEET 9C)
 MONITORING WELL #8

THIS POND AT 2.5 ACRE-FT VOLUME (IN COMBINATION WITH THE 1.6 ACRE-FT SEDIMENT TRAP UPSTREAM) WILL TREAT 100 YR 24 HR STORM

LEGEND

--- PROPERTY LINE	--- PROPOSED CONTOURS MAJOR
--- EXISTING ROADS	--- PROPOSED CONTOURS MINOR
--- EXISTING CONTOURS MAJOR	--- SILT FENCE
--- EXISTING CONTOURS MINOR	--- DRAINAGES
--- EXISTING DRAINAGES	█ PROPOSED DIKE

Volume

Base Surface	ASH LANDFILL 2
Comparison Surface	POND 18 FINAL
Cut volume (unadjusted)	6350 Cu. Yd.
Fill volume (unadjusted)	1500 Cu. Yd.
Net volume (unadjusted)	4850 Cu. Yd.<Cut>

NOTE: CONTRACTOR TO INSTALL CLAY LINER IN POND TO ELEVATION 6356.0 (SEE DESIGN REPORT FOR LINER SPECIFICATIONS)

SUNNYSIDE COGENERATION ASSOC.
 SCA #2 ASH LANDFILL CONSTRUCTION DRAWING
 SEDIMENT POND #018 DESIGN
 Carbon County, Utah

TWIN PEAKS
 Engineering & Land Surveying
 2264 NORTH 1450 EAST LEHI, UTAH 84043
 (801) 450-3511, (801) 438-0700 FAX

DWG DATE: JUNE 2013
 PLOT DATE: 28 June 2013

SHEET: 9

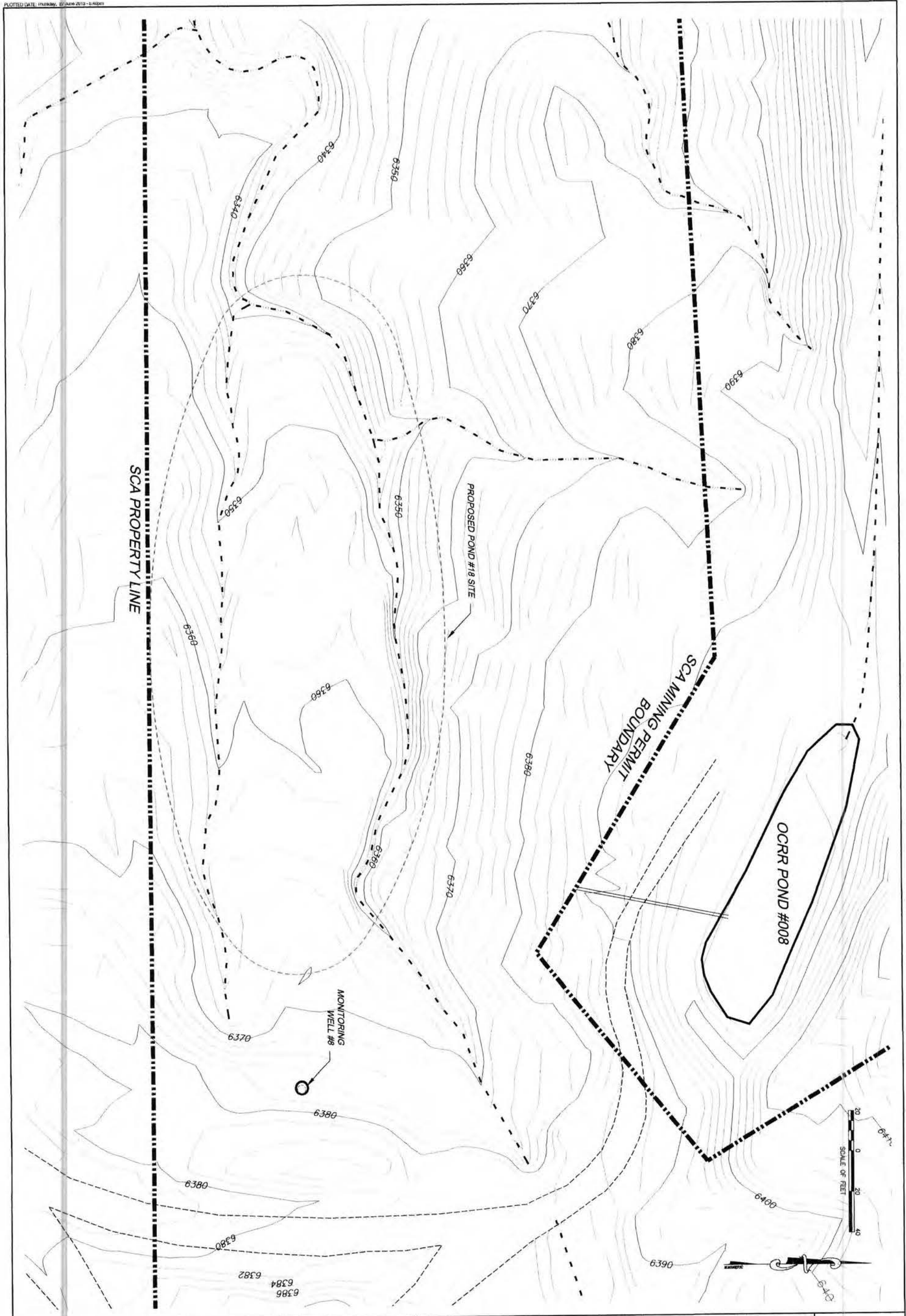

9A

TWIN PEAKS
 Engineering & Land Surveying
 2264 NORTH 1450 EAST LEHI, UTAH 84043
 (801) 450-3511, (801) 439-0700 FAX

SUNNYSIDE COGENERATION ASSOC.
 SCA #2 ASH LANDFILL CONSTRUCTION DRAWINGS
 SEDIMENT POND #018 EXISTING CONDITIONS
 Carbon County, Utah

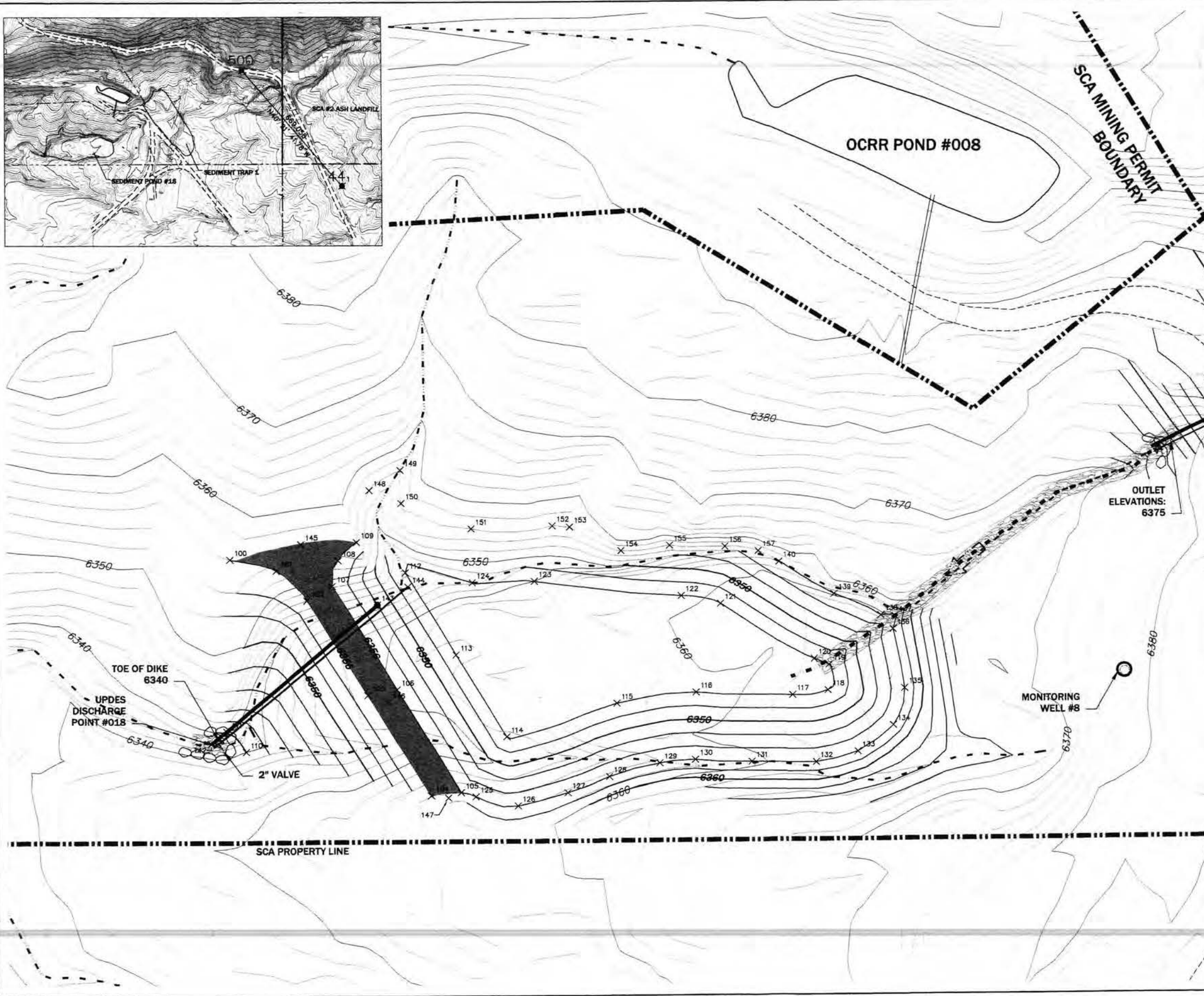
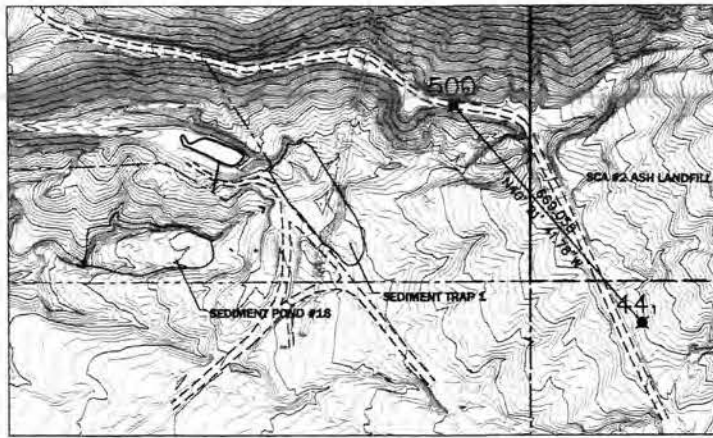

Point #	Northing	Easting	Elevation	Raw Description
1	42029.67	47570.37	6449.87	AERIAL POINT 44
2	42539.48	47527.08	6429.87	AERIAL POINT 500gate
100	42281.51	46286.12	6356.00	dike
101	42248.50	46306.13	6356.00	dike
102	42232.08	46319.38	6356.00	dike
103	42190.98	46345.39	6356.00	dike
104	42146.07	46372.88	6356.00	dike
105	42147.39	46386.09	6356.00	top clay liner
106	42193.48	46388.31	6356.00	top clay liner
107	42239.57	46390.54	6356.00	top clay liner
108	42280.96	46333.06	6356.00	top clay liner
109	42289.01	46343.04	6356.00	top clay liner
110	42165.92	46292.68	6340.00	top dike
111	42178.02	46284.43	6340.00	top dike
112	42245.54	46262.27	6346.00	top dike
113	42208.91	46384.21	6346.00	top dike
114	42172.28	46406.54	6346.00	top dike
115	42186.90	46454.26	6346.00	top pond
116	42191.68	46489.02	6346.00	top pond
117	42190.26	46531.88	6346.00	top pond
118	42193.34	46547.41	6346.00	top pond
119	42203.73	46547.91	6346.00	top pond
120	42206.26	46541.29	6346.00	top pond
121	42181.10	46499.98	6346.00	top pond
122	42234.87	46483.01	6346.00	top pond
123	42241.49	46418.77	6346.00	top pond
124	42240.96	46392.65	6346.00	top pond
125	42146.51	46392.46	6356.00	top clay liner
126	42141.38	46410.90	6356.00	top clay liner
127	42147.21	46432.56	6356.00	top clay liner
128	42184.20	46450.77	6356.00	top clay liner
129	42180.14	46473.05	6356.00	top clay liner
130	42181.62	46488.47	6356.00	top clay liner
131	42180.58	46513.38	6356.00	top clay liner
132	42180.28	46541.77	6356.00	top clay liner
133	42184.94	46560.54	6356.00	top clay liner
134	42176.47	46578.82	6356.00	top clay liner
135	42192.88	46580.97	6356.00	top clay liner
136	42218.28	46578.02	6356.00	top clay liner
137	42225.02	46576.94	6356.00	top clay liner
138	42225.54	46570.77	6356.00	top clay liner
139	42235.13	46550.31	6356.00	top clay liner
140	42249.00	46526.52	6356.00	top clay liner
141	42189.48	46277.70	6339.00	3\"/>

NOTE: STAKEOUT COORDINATES ARE PROVIDED FOR THE CONVENIENCE OF THE CONSTRUCTION TEAM.
 THE CONTRACTOR SHALL BE RESPONSIBLE FOR PROPER LAYOUT AND CONSTRUCTION OF THIS FACILITY

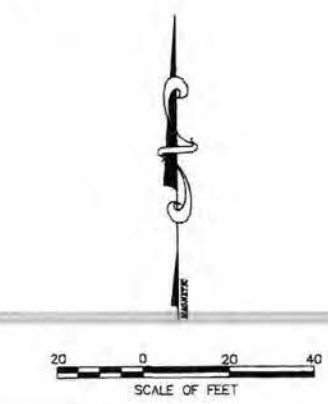

SUNNYSIDE COGENERATION ASSOC.
SCA #2 ASH LANDFILL CONSTRUCTION DRAWINGS
SEDIMENT POND #018 SURVEY CONTROL
 Carbon County, Utah

TWIN PEAKS
 Engineering & Land Surveying
 2264 NORTH 1450 EAST LEM, UTAH 84043
 (801) 450-3511, (801) 439-0700 FAX

DATE: JUNE 2013
 DATE: 06 August 2013
 SHEET: 9B

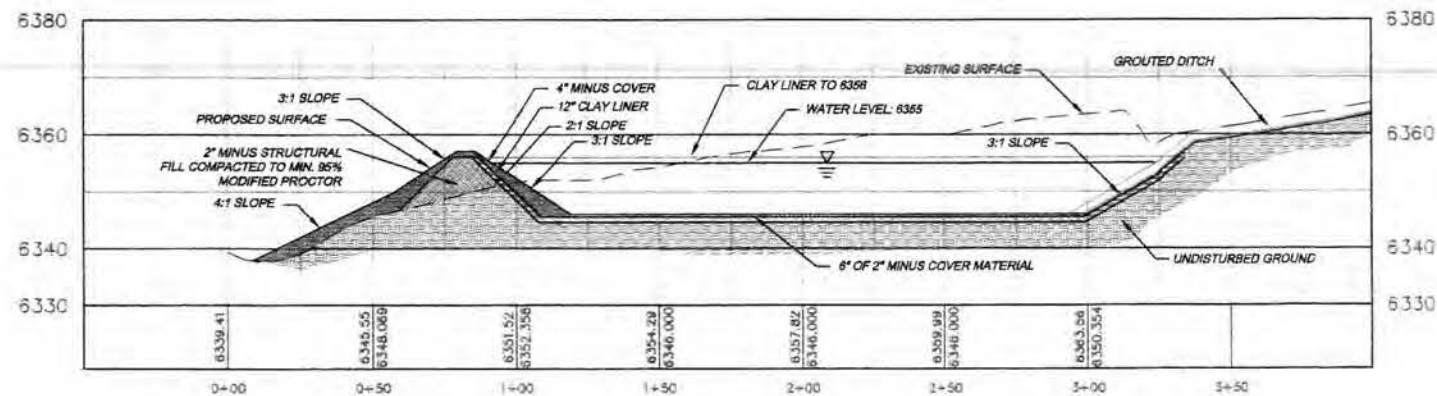

ALIGNMENT G SCALE: H 1"=30 V 1"=15

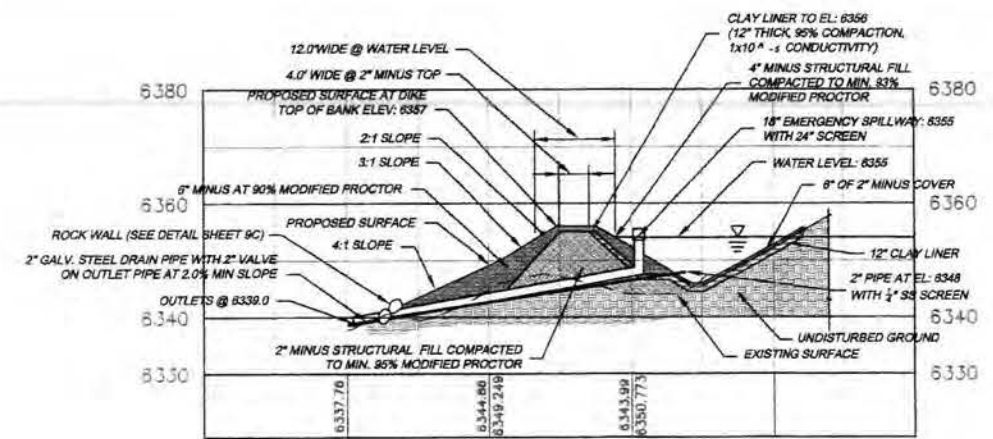

ALIGNMENT F SCALE: H 1"=30 V 1"=15

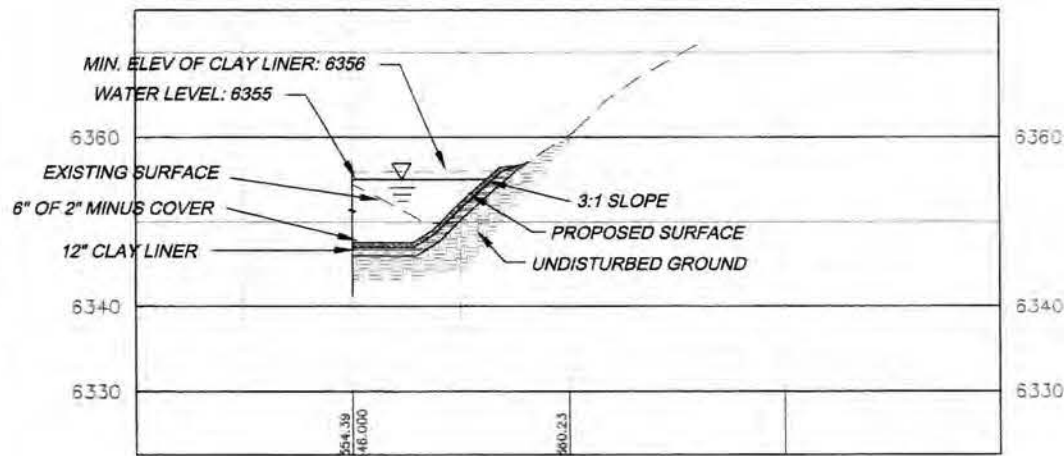

ALIGNMENT H2 SCALE: H 1"=20 V 1"=10

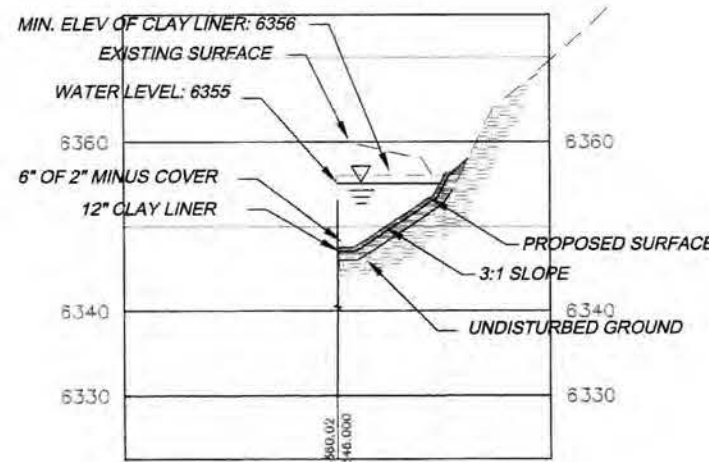

ALIGNMENT J2 SCALE: H 1"=20 V 1"=10

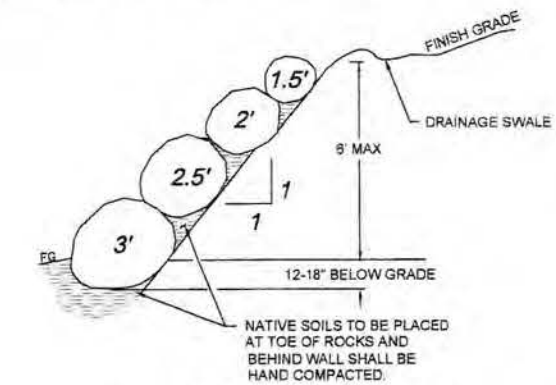

ROCK RETAINING WALL DETAIL
NOT TO SCALE

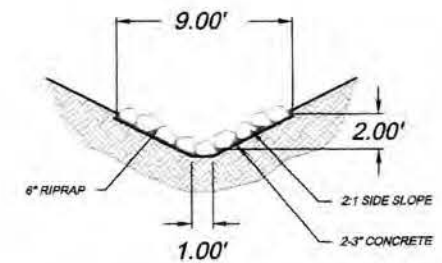

DITCH WITH GROUDED RIPRAP

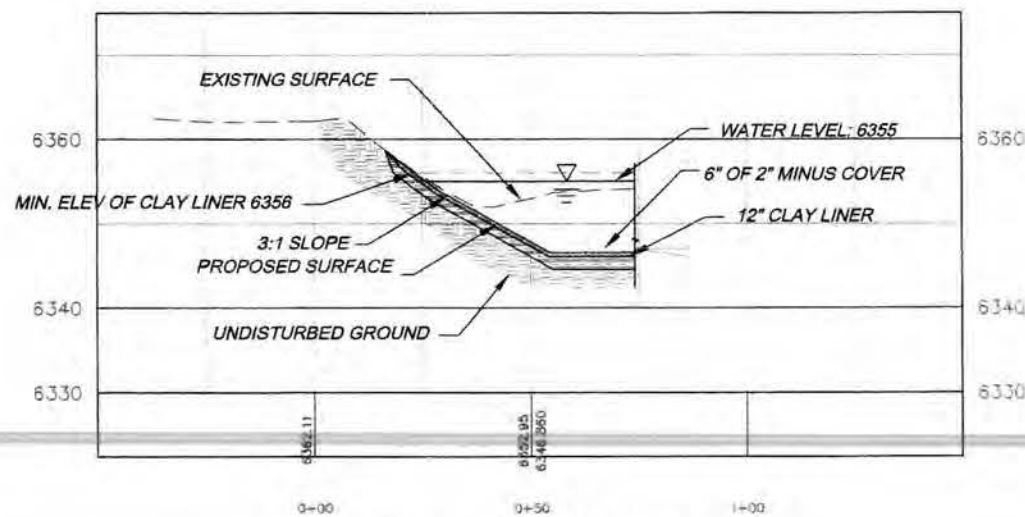

ALIGNMENT H1 SCALE: H 1"=20 V 1"=10

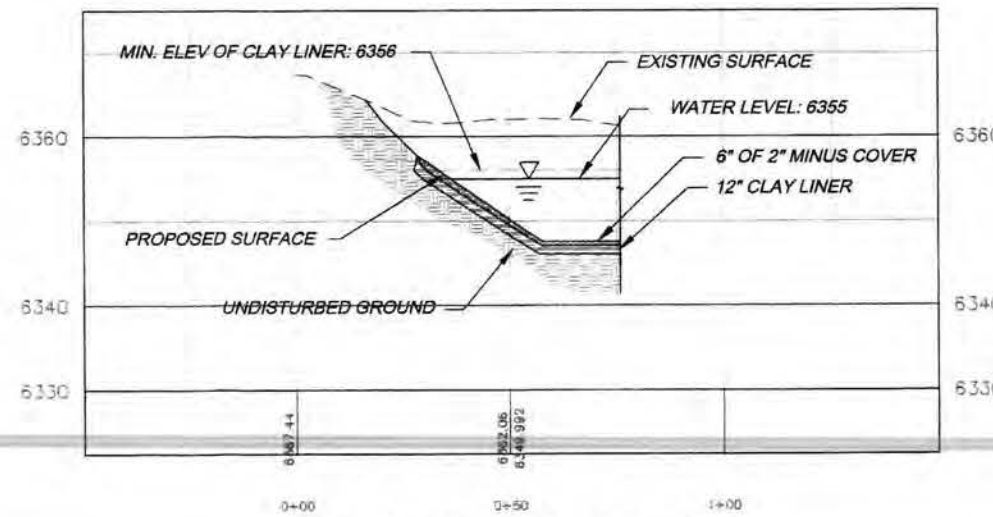

ALIGNMENT J1 SCALE: H 1"=20 V 1"=10

NOTE:

- CONTRACTOR TO INSTALL CLAY LINER IN POND TO ELEVATION 6356.0 (SEE DESIGN REPORT FOR LINER SPECIFICATIONS)
- DETECTA TAPE SHALL BE PLACED BETWEEN THE CLAY LINER AND THE SOIL COVER MATERIAL AT INTERVALS NOT EXCEEDING 5 FT.

SUNNYSIDE COGENERATION ASSOC.
 SCA #2 ASH LANDFILL CONSTRUCTION DRAWINGS
 SEDIMENT POND #018 CROSS SECTIONS
 Carbon County, Utah

TWIN PEAKS
 Engineering & Land Surveying
 2264 NORTH 1450 EAST LEHI, UTAH 84043
 (801) 450-3511, (801) 438-0700 FAX

DATE: JUNE 2013
 PLOT DATE: 28 June 2013

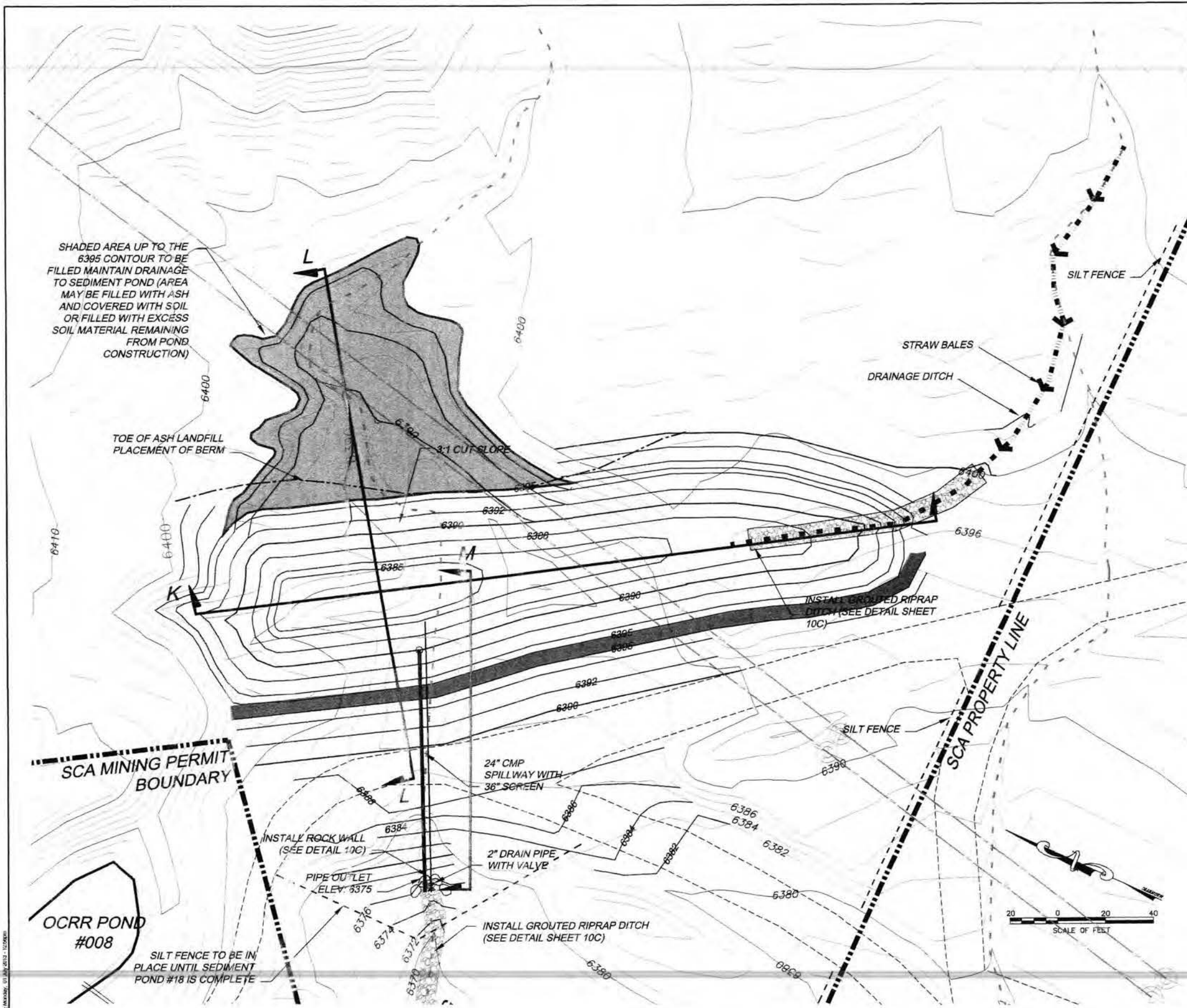

Volume	
Base Surface	ASH LANDFILL 2
Comparison Surface	LOWER SED FINAL
Cut volume (unadjusted)	2450 Cu. Yd.
Fill volume (unadjusted)	1850 Cu. Yd.
Net volume (unadjusted)	600 Cu. Yd.<Cut>
Volume	
Base Surface	ASH LANDFILL 2
Comparison Surface	LOWER SED EX-FILL SURFAC
Cut volume (unadjusted)	0.0 Cu. Yd.
Fill volume (unadjusted)	850 Cu. Yd.
Net volume (unadjusted)	850 Cu. Yd.<Fill>

- NOTES:
1. APPROXIMATE VOLUME OF SEDIMENT TRAP 1.6 ACRE FEET.
 2. SINCE THE 2" DRAIN PIPE IS EXPECTED TO NORMALLY BE OPEN, NO WATER WILL REMAIN IN THIS SEDIMENT TRAP FOR LONG DURATIONS. THEREFORE NO CLAY LINER REQUIRED FOR THIS SEDIMENT TRAP.
 3. ALL DISTURBED AREAS TO BE REVEGETATED PER SCA REQUIREMENTS.

LEGEND

	PROPERTY LINE
	EXISTING ROADS
	EXISTING DRAINAGES
	EXISTING CONTOURS
	MAJOR
	MINOR
	PROPOSED CONTOURS
	MAJOR
	MINOR
	SILT FENCE
	DRAINAGES
	PROPOSED DIKE

SUNNYSIDE COGENERATION ASSOC.
 SCA #2 ASH LANDFILL CONSTRUCTION DRAWINGS
 SEDIMENT TRAP #1 DESIGN
 Carbon County, Utah

TWIN PEAKS
 Engineering & Land Surveying
 2264 NORTH 1450 EAST LEHI, UTAH 84043
 (801) 450-3511, (801) 459-0700 FAX

DWG DATE: JUNE 2013
 PLOT DATE: 13 July 2013

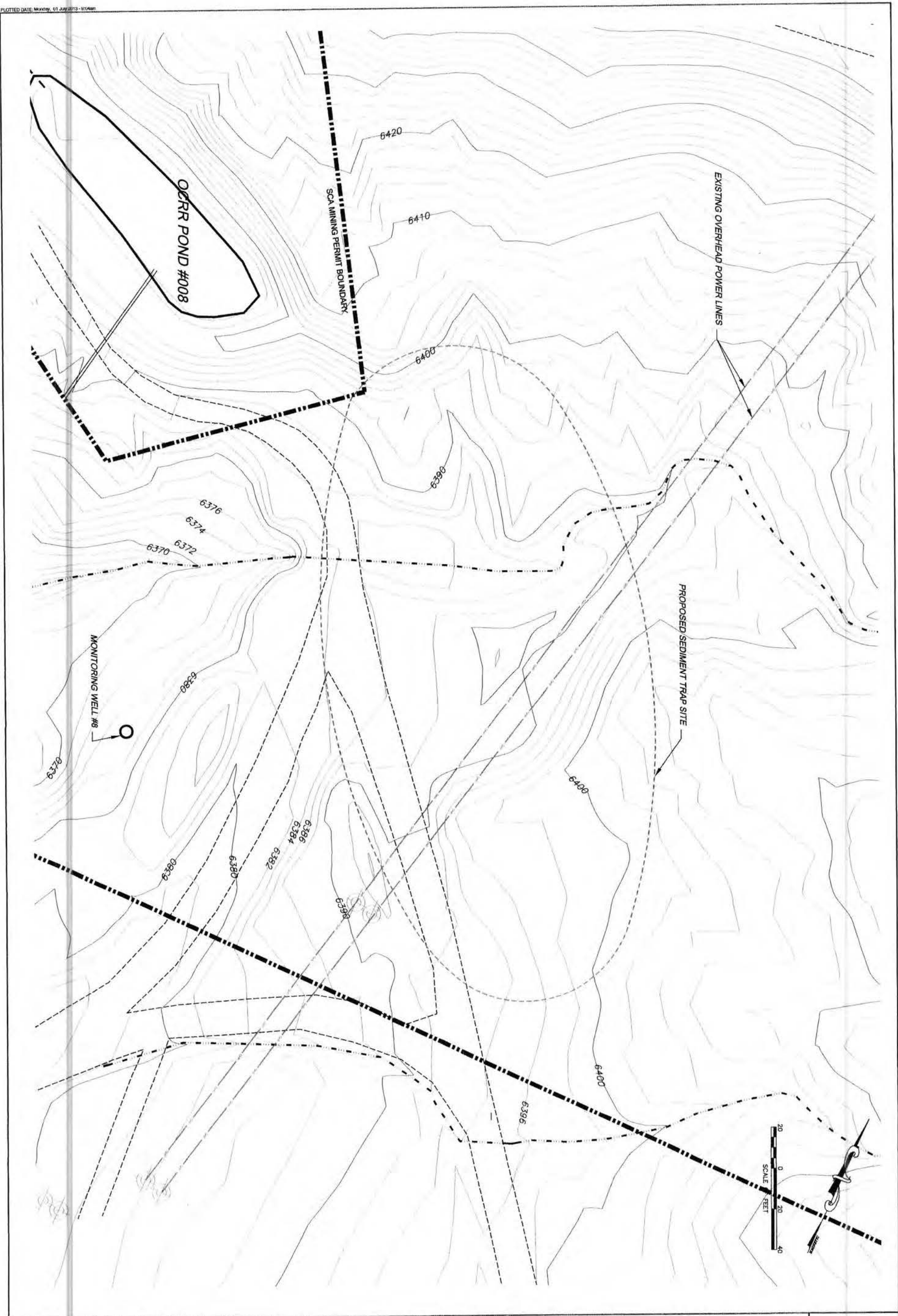

10A

DATE PLOTTED: JUNE 2013
 PLOTTED BY: 01 July 2013

TWIN PEAKS
 Engineering & Land Surveying
 2264 NORTH 1450 EAST LEHI, UTAH 84043
 (801) 450-3511, (801) 439-0700 FAX

SUNNYSIDE COGENERATION ASSOC.
 SCA #2 ASH LANDFILL CONSTRUCTION DRAWINGS
 SEDIMENT TRAP #1 EXISTING CONDITIONS
 Carbon County, Utah

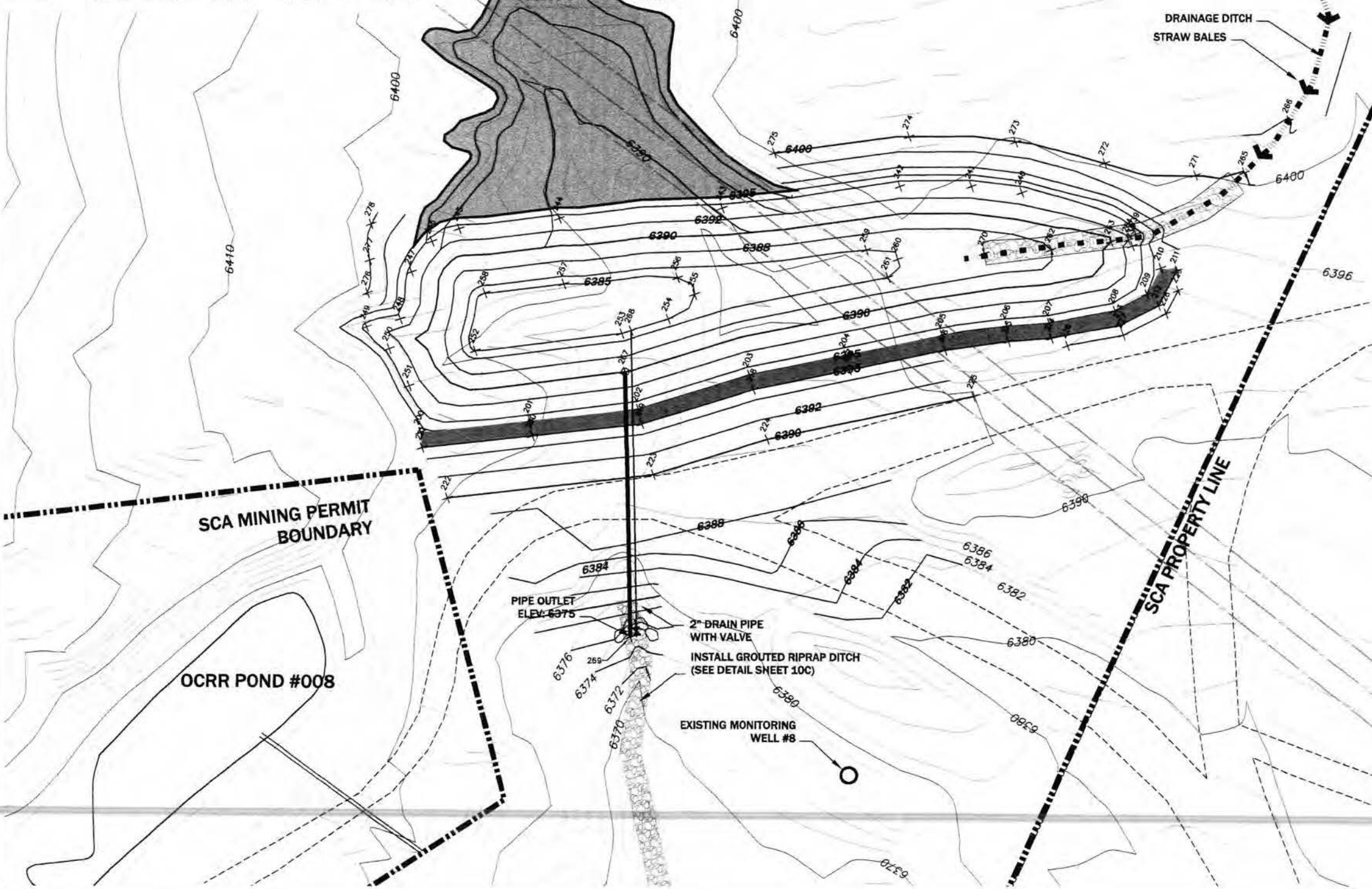
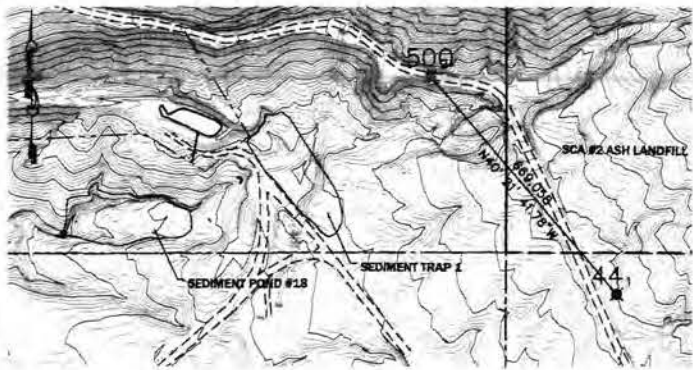

Point #	Northing	Easting	Elevation	Raw Description
1	42029.67	47570.97	6449.87	AERIAL POINT 44
2	42539.48	47137.08	6429.87	AERIAL POINT 900-gate
200	42405.81	48728.34	6395.00	TOP DIKE
201	42369.66	48790.26	6395.00	TOP DIKE
202	42333.52	48772.18	6395.00	TOP DIKE
203	42300.80	48802.20	6395.00	TOP DIKE
204	42270.07	48825.00	6395.00	TOP DIKE
205	42239.54	48847.80	6395.00	TOP DIKE
206	42218.80	48861.52	6395.00	TOP DIKE
207	42204.19	48866.55	6395.00	TOP DIKE
208	42183.19	48884.56	6395.00	TOP DIKE
209	42174.89	48895.66	6395.00	TOP DIKE
210	42174.19	48907.15	6395.00	TOP DIKE
211	42168.11	48908.86	6395.00	TOP DIKE
212	42168.78	48933.40	6395.00	TOP DIKE
213	42178.96	48860.19	6395.00	TOP DIKE
214	42200.97	48864.48	6395.00	TOP DIKE
215	42215.39	48856.38	6395.00	TOP DIKE
216	42236.10	48842.88	6395.00	TOP DIKE
217	42266.44	48820.23	6395.00	TOP DIKE
218	42298.77	48797.07	6395.00	TOP DIKE
219	42329.91	48787.28	6395.00	TOP DIKE
220	42366.30	48745.28	6395.00	TOP DIKE
221	42402.89	48733.21	6395.00	TOP DIKE
222	42388.84	48709.55	6390.00	TOE DIKE
223	42317.85	48751.30	6390.00	TOE DIKE
224	42284.00	48782.15	6390.00	TOE DIKE
225	42218.89	48831.23	6390.00	TOE DIKE
226	42183.84	48864.49	6394.00	TOE DIKE
227	42176.16	48877.28	6394.00	TOE DIKE
228	42184.84	48891.96	6394.00	TOE DIKE
229	42164.40	48902.07	6394.00	TOE DIKE
238	42187.81	48910.38	6393.80	WATER LEVEL
239	42188.41	48915.14	6392.50	WATER LEVEL
240	42205.17	48911.18	6393.50	WATER LEVEL
241	42283.83	48905.13	6393.50	WATER LEVEL
242	42278.79	48893.37	6392.00	WATER LEVEL
243	42237.43	48856.70	6393.80	WATER LEVEL
244	42292.43	48826.81	6393.50	WATER LEVEL
245	42426.79	48806.56	6393.50	WATER LEVEL
246	42403.06	48797.86	6393.50	WATER LEVEL
247	42435.20	48783.96	6393.50	WATER LEVEL
248	42451.33	48765.19	6393.50	WATER LEVEL
249	42441.93	48756.88	6392.80	WATER LEVEL
250	42430.24	48752.83	6392.80	WATER LEVEL
251	42417.35	48742.99	6393.50	WATER LEVEL
252	42400.16	48765.98	6385.00	TOE POND
253	42351.76	48796.14	6385.00	TOE POND
254	42337.97	48806.78	6380.00	TOE POND
255	42323.94	48811.70	6385.00	TOE POND
256	42341.86	48824.19	6385.00	TOE POND
257	42380.14	48804.11	6385.00	TOE POND
258	42406.42	48787.89	6385.00	TOE POND
259	42280.28	48865.37	6386.00	INNER POND
260	42267.84	48867.28	6386.00	INNER POND
261	42268.12	48859.20	6386.00	INNER POND
262	42218.47	48895.77	6388.00	DRAINAGE CHANNEL
263	42195.96	48908.32	6390.00	DRAINAGE CHANNEL
264	42189.98	48911.89	6392.00	DRAINAGE CHANNEL
265	42180.77	48954.42	6400.00	DRAINAGE CHANNEL
266	42153.96	48980.10	6402.00	DRAINAGE CHANNEL
267	42344.34	48783.08	6382.00	PIPE FLOW LINE
268	42349.00	48796.66	6386.00	FLOW 2" DRAIN LINE
269	42289.06	48890.11	6378.00	INVERT 18" CMP
270	42238.29	48863.57	6387.30	END GROUTED DITCH
271	42177.28	48845.60	6400.00	top of cut
272	42210.87	48938.09	6400.00	top of cut
273	42249.88	48928.07	6400.00	top of cut
274	42283.76	48912.55	6400.00	top of cut
275	42328.42	48884.53	6400.00	top of cut
276	42446.76	48789.14	6386.00	top of cut
277	42481.43	48781.09	6398.00	top of cut
278	42466.81	48794.07	6398.00	top of cut

NOTE: STAKEOUT COORDINATES ARE PROVIDED FOR THE CONVENIENCE OF THE CONSTRUCTION TEAM.
 THE CONTRACTOR SHALL BE RESPONSIBLE FOR PROPER LAYOUT AND CONSTRUCTION OF THIS FACILITY

SUNNYSIDE COGENERATION ASSOC.
SCA #2 ASH LANDFILL CONSTRUCTION DRAWINGS
SEDIMENT TRAP #1 SURVEY CONTROL
 Carbon County, Utah

TWIN PEAKS
 Engineering & Land Surveying
 2264 NORTH 1430 EAST LEHI, UTAH 84043
 (801) 450-3511, (801) 439-0700 FAX

DATE: JUNE 2013
 PLOT DATE: 03 August 2013

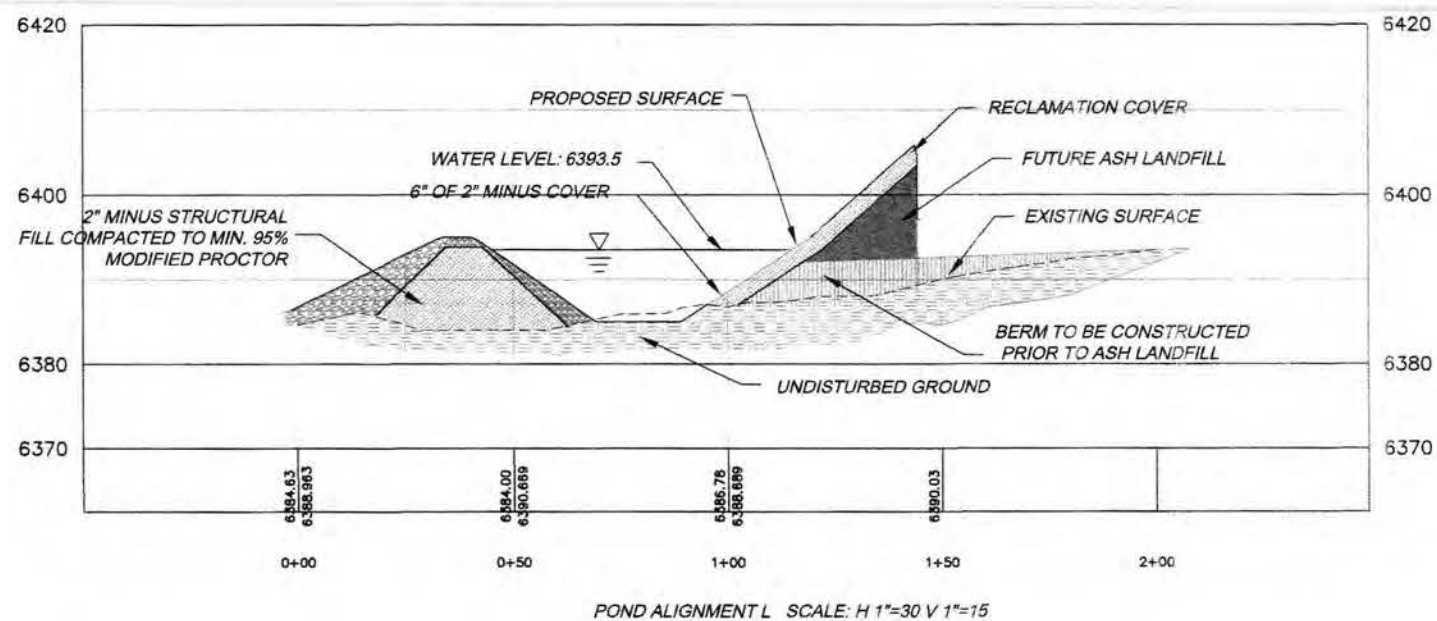

POND ALIGNMENT L SCALE: H 1"=30 V 1"=15

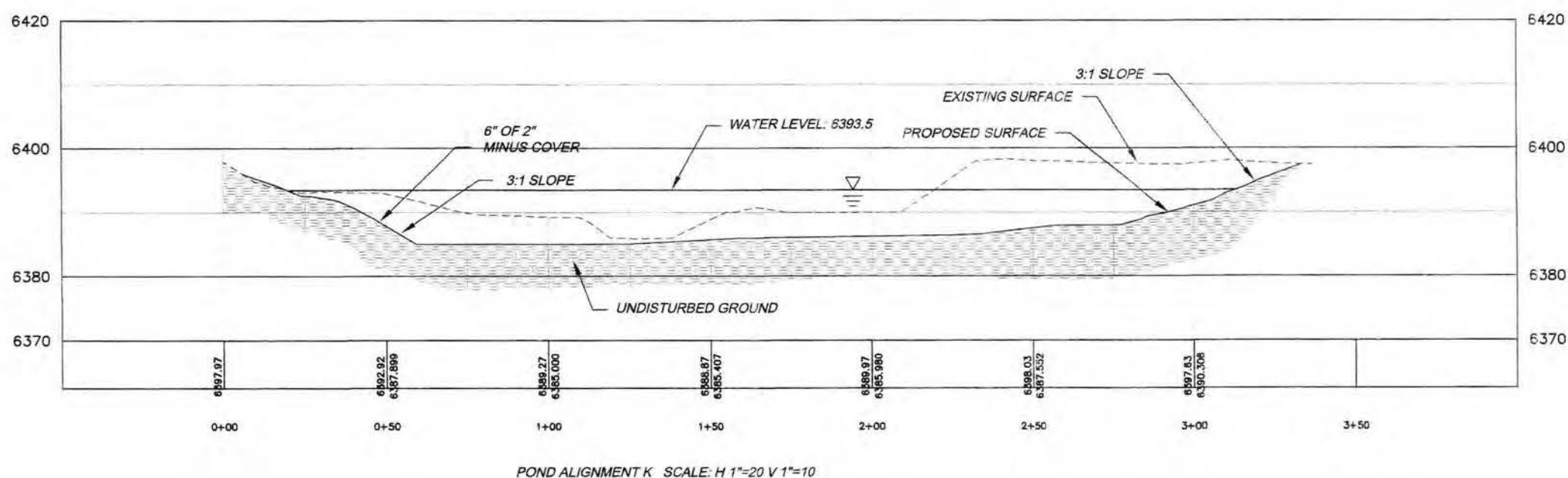

POND ALIGNMENT K SCALE: H 1"=20 V 1"=10

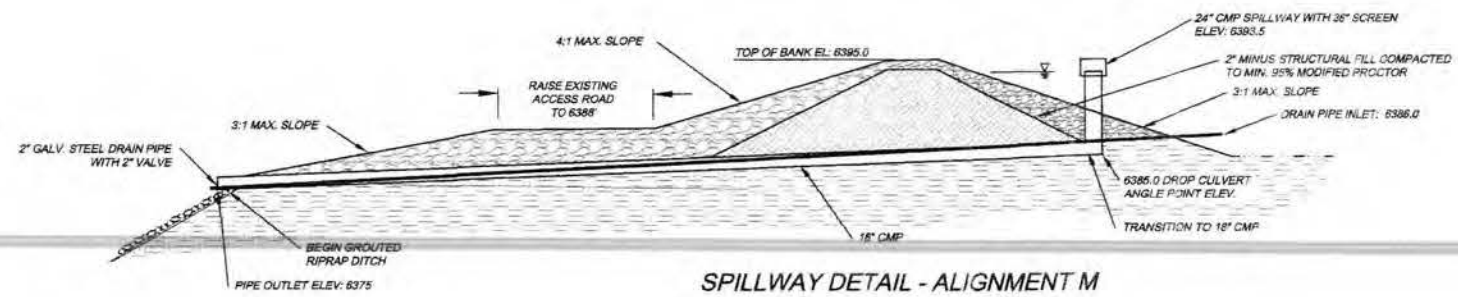

SPILLWAY DETAIL - ALIGNMENT M

SUNNYSIDE COGENERATION ASSOC.
 SCA #2 ASH LANDFILL GROUNDWATER PERMIT SUBMITTAL
 SEDIMENT TRAP #1 CROSS SECTION
 Carbon County, Utah



DATE: JUNE 2013
 DATE: 12 August 2013

Volume
 Base Surface ASH LANDFILL 2
 Comparison Surface UPPER POND FINAL
 Cut volume (unadjusted) 4700 Cu. Yd.
 Fill volume (unadjusted) 2650 Cu. Yd.
 Net volume (unadjusted) 2050 Cu. Yd.<Cut>

NOTES:
 1. APPROXIMATE VOLUME OF SEDIMENT TRAP 1.4 ACRE FEET.
 2. SINCE THE 2" DRAIN PIPE IS EXPECTED TO NORMALLY BE OPEN, NO WATER WILL REMAIN IN THIS SEDIMENT TRAP FOR LONG DURATIONS. THEREFORE NO CLAY LINER REQUIRED FOR THIS SEDIMENT TRAP.

- LEGEND
- PROPERTY LINE
 - EXISTING ROADS
 - RECLAIMED ROADS
 - EXISTING CONTOURS
MAJOR
MINOR
 - PROPOSED CONTOURS
MAJOR
MINOR
 - PROPOSED ROADS
 - SILT FENCE
 - DRAINAGES
 - ██████ PROPOSED DIKE



SUNNYSIDE COGENERATION ASSOC.
 SCA #2 ASH LANDFILL CONSTRUCTION DRAWINGS
 SEDIMENT TRAP #2 DESIGN
 Carbon County, Utah

TWIN PEAKS
 Engineering & Land Surveying
 1011 W. 30th St., Suite 100, P.O. Box 10000, Farmington, UT 84201
 (407) 456-3511, (801) 629-0100 FAX

DATE	NOV 2012
BY	23 JUN 12
BY	
BY	
BY	

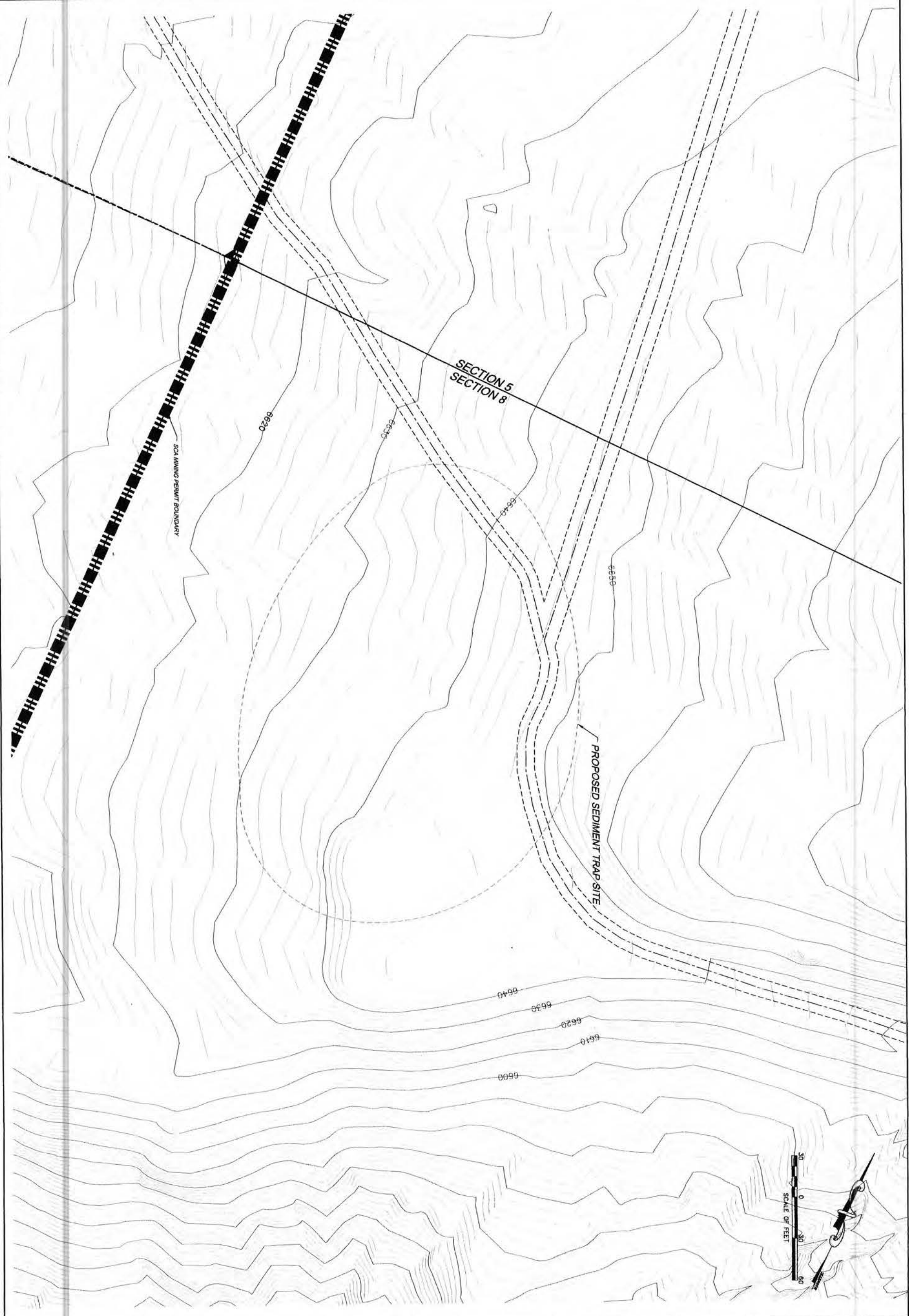

DATE PLOTTED	JUNE 2013
DATE	27 JUNE 2013
PROJECT	11A
SHEET	12

TWIN PEAKS
 Engineering & Land Surveying
 2264 NORTH 1450 EAST LEHI, UTAH 84043
 (801) 450-3511, (801) 439-0700 FAX

SUNNYSIDE COGENERATION ASSOC.
 SCA #2 ASH LANDFILL CONSTRUCTION DRAWINGS
 SEDIMENT TRAP #2 EXISTING CONDITIONS
 Carbon County, Utah

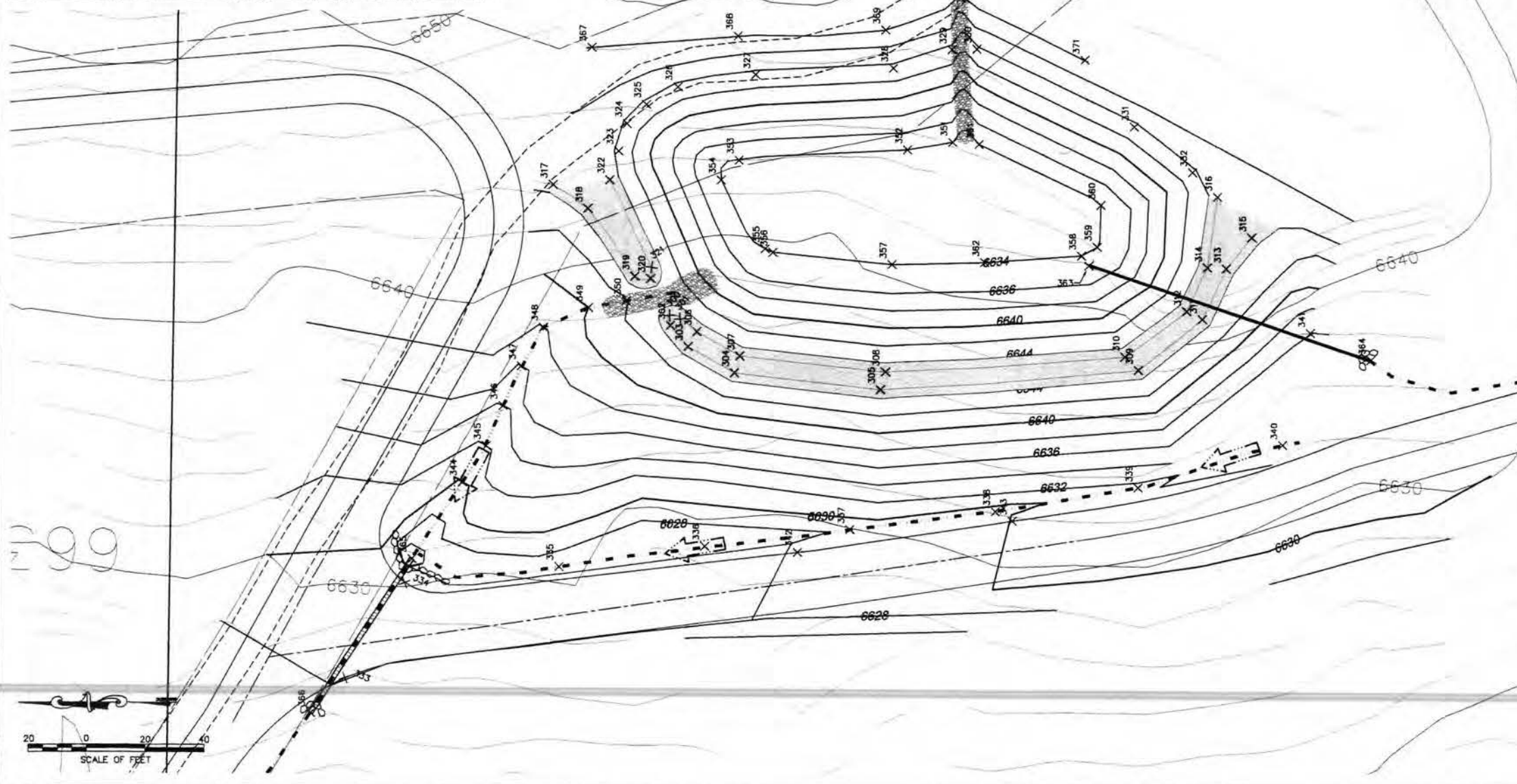
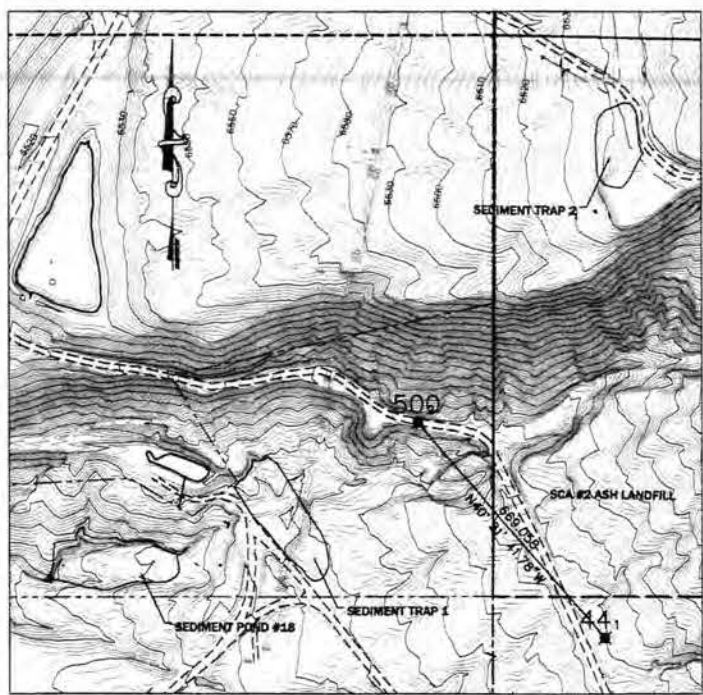

Point #	Northing	Eastng	Elevation	Raw Description
1	42026.67	47070.37	6449.87	AERIAL POINT 44
2	42526.46	47137.08	6439.87	AERIAL POINT 500-gm
300	43276.01	47868.98	6645.00	TOP DIKE
301	43272.51	47864.35	6645.00	TOP DIKE
302	43275.77	47862.07	6645.00	TOP DIKE
303	43268.78	47854.74	6645.00	TOP DIKE
304	43265.08	47845.62	6645.00	TOP DIKE
305	43204.15	47839.78	6645.00	TOP DIKE
306	43266.74	47858.91	6645.00	TOP DIKE
307	43252.19	47851.48	6645.00	TOP DIKE
308	43202.51	47845.93	6645.00	TOP DIKE
309	43125.80	47848.47	6645.00	TOP DIKE
310	43120.03	47851.12	6645.00	TOP DIKE
311	43093.64	47844.13	6645.00	TOP DIKE
312	43088.99	47866.89	6645.00	TOP DIKE
313	43085.30	47881.65	6645.00	TOP DIKE
314	43091.77	47882.02	6645.00	TOP DIKE
315	43076.80	47892.46	6645.00	TOP DIKE
316	43088.14	47806.44	6645.00	TOP DIKE
317	43113.70	47810.77	6645.00	TOP DIKE
318	43028.87	47802.58	6645.00	TOP DIKE
319	43287.91	47879.09	6645.00	TOP DIKE
320	43282.34	47878.29	6645.00	TOP DIKE
321	43282.23	47882.12	6645.00	TOP DIKE
322	43286.34	47812.41	6645.00	TOP DIKE
323	43292.15	47822.38	6643.50	SLOPE AT WATER LEVEL
324	43290.19	47831.94	6643.50	SLOPE AT WATER LEVEL
325	43283.64	47836.59	6643.50	SLOPE AT WATER LEVEL
326	43272.85	47844.64	6643.50	SLOPE AT WATER LEVEL
327	43246.30	47848.88	6643.50	SLOPE AT WATER LEVEL
328	43199.19	47851.09	6643.50	SLOPE AT WATER LEVEL
329	43179.23	47857.47	6643.50	SLOPE AT WATER LEVEL
330	43170.76	47857.71	6643.50	SLOPE AT WATER LEVEL
331	43158.41	47830.81	6643.50	SLOPE AT WATER LEVEL
332	43096.65	47814.93	6643.50	SLOPE AT WATER LEVEL
333	43367.10	47440.26	6626.00	EDGE OF ROAD
334	43366.82	47472.95	6629.00	EDGE OF ROAD
335	43314.33	47478.38	6627.40	DRAINAGE
336	43264.39	47485.42	6627.90	DRAINAGE
337	43214.78	47491.22	6628.70	DRAINAGE
338	43165.12	47491.48	6629.50	DRAINAGE
339	43125.74	47505.06	6631.58	DRAINAGE
340	43066.37	47520.42	6632.30	DRAINAGE
341	43056.84	47559.35	6636.00	TOE DIKE
342	43223.76	47483.35	6628.20	EDR
343	43159.15	47494.10	6630.00	EDR
344	43347.18	47807.80	6630.00	DRAINAGE
345	43339.02	47820.44	6632.00	DRAINAGE
346	43333.27	47834.33	6634.00	DRAINAGE
347	43326.86	47848.01	6636.00	DRAINAGE
348	43315.15	47861.44	6638.00	DRAINAGE
349	43308.87	47868.28	6640.00	DRAINAGE
350	43290.81	47870.59	6642.00	DRAINAGE
351	43179.06	47825.41	6634.00	TOE POND
352	43194.46	47822.78	6634.00	TOE POND
353	43253.13	47819.20	6634.00	TOE POND
354	43268.34	47812.41	6634.00	TOE POND
355	43243.35	47868.62	6634.00	TOE POND
356	43240.74	47887.29	6634.00	TOE POND
357	43200.02	47883.14	6634.00	TOE POND
358	43134.68	47886.12	6634.00	TOE POND
359	43129.54	47889.20	6634.00	TOE POND
360	43127.98	47903.67	6634.00	TOE POND
361	43170.10	47824.70	6634.00	TOE POND
362	43164.42	47883.81	6634.00	TOE POND
363	43132.13	47892.65	6636.00	2" DRAIN PIPE INLET
364	43036.96	47849.97	6635.00	2" PIPE OUTLET
365	43364.40	47481.23	6625.00	18" dia outlet
366	43396.90	47428.25	6624.00	18" dia outlet
367	43302.10	47658.34	6648.00	top of cut
368	43292.27	47662.30	6648.00	top of cut
369	43201.74	47664.27	6648.00	top of cut
370	43176.04	47675.39	6648.00	top of cut
371	43133.27	47653.91	6648.00	top of cut

NOTE: STAKEOUT COORDINATES ARE PROVIDED FOR THE CONVENIENCE OF THE CONSTRUCTION TEAM.
 THE CONTRACTOR SHALL BE RESPONSIBLE FOR PROPER LAYOUT AND CONSTRUCTION OF THIS FACILITY

SUNNYSIDE COGENERATION ASSOC.
SCA #2 ASH LANDFILL CONSTRUCTION DRAWINGS
SEDIMENT POND #2 SURVEY CONTROL
 Carbon County, Utah

TWIN PEAKS
 Engineering & Land Surveying
 2264 NORTH 1450 EAST LEHI, UTAH 84043
 (801) 450-3511, (801) 439-0700 FAX

ISSUE DATE: **JUNE 2013**
 PLOT DATE: 06 August 2013

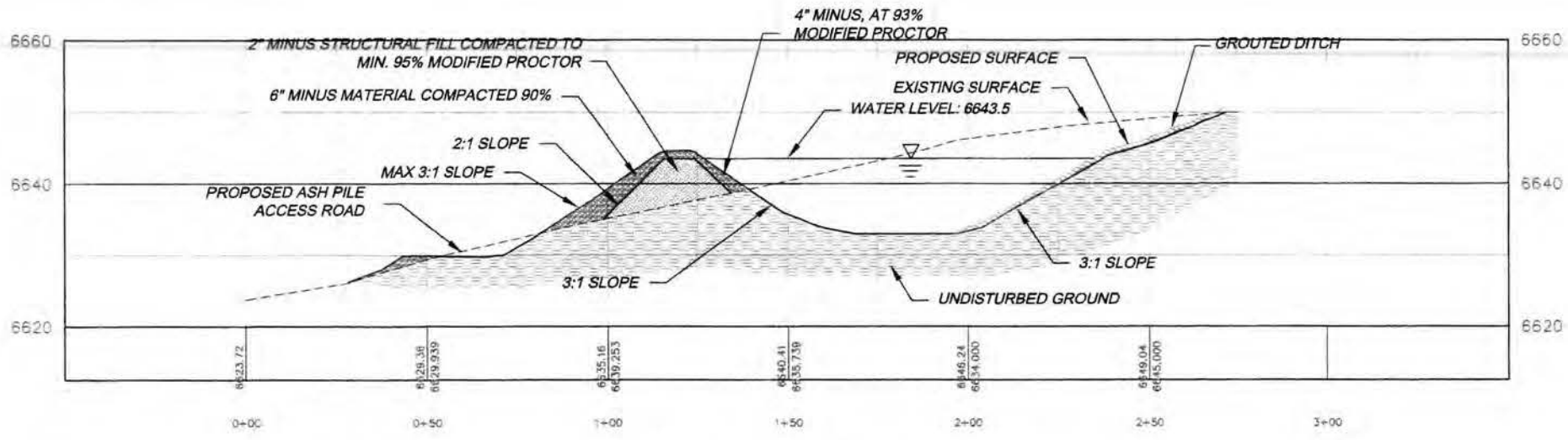

ALIGNMENT N SCALE: H 1"=20 V 1"=10

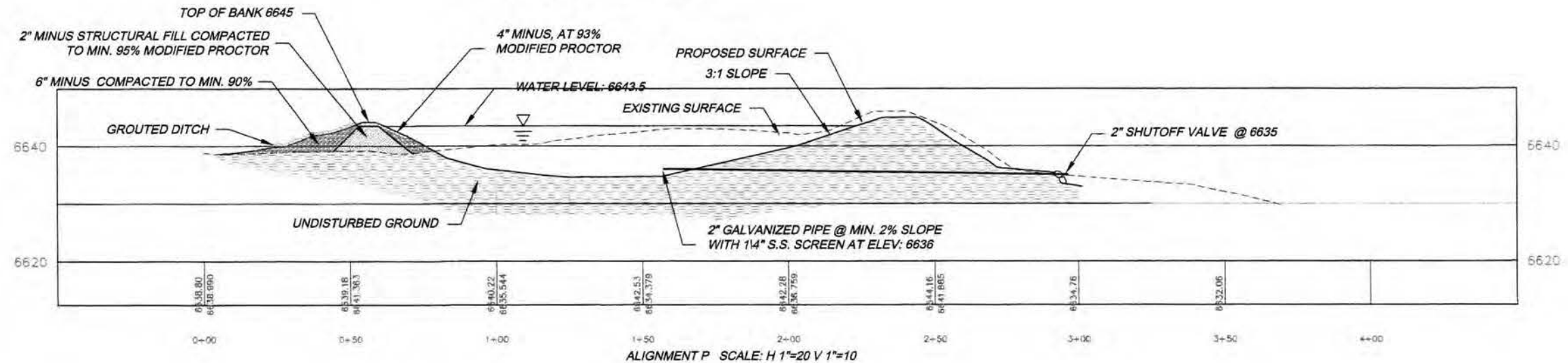

ALIGNMENT P SCALE: H 1"=20 V 1"=10

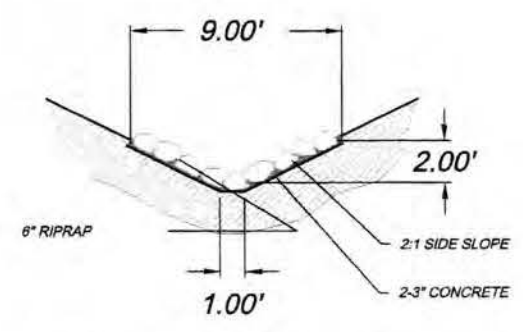

DITCH WITH GROUTED RIPRAP
SCALE: N.T.S.

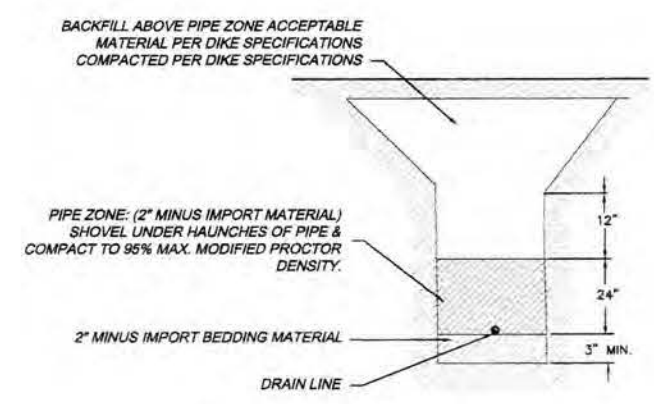

TYPICAL PIPE TRENCH
SCALE: N.T.S.

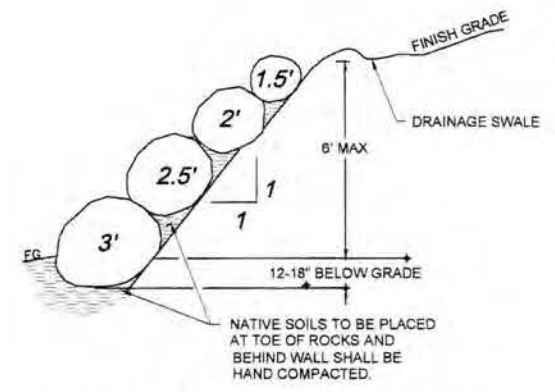

ROCK RETAINING WALL DETAIL
NOT TO SCALE

SUNNYSIDE COGENERATION ASSOC.
SCA #2 ASH LANDFILL CONSTRUCTION DRAWINGS
SEDIMENT TRAP #2 CROSS SECTIONS & DETAILS
Carbon County, Utah

TWIN PEAKS
Engineering & Land Surveying
2264 NORTH 1450 EAST LEHI, UTAH 84043
(801) 450-3511, (801) 439-0700 FAX

DATE: JUNE 2013
PLAT DATE: 29 June 2013

SHEET: 11C
12

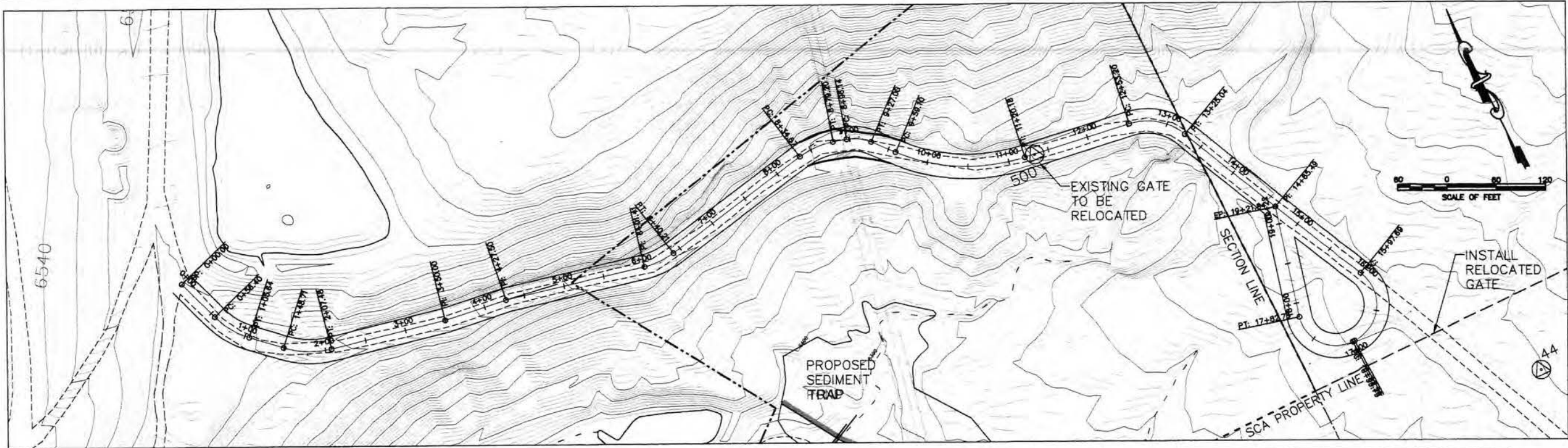

SUNNYSIDE COGENERATION ASSOC.
SCA #2 ASH LANDFILL-CONSTRUCTION DRAWINGS
LOWER ACCESS ROAD DESIGN
 Carbon County, Utah

TWIN PEAKS
 Engineering & Land Surveying
 2264 NORTH 1450 EAST LEHI, UTAH 84043
 (801) 450-5511, (801) 439-0700 FAX

DATE: AUGUST 2013
 PLOT DATE: 13 August 2013

SHEET 12
 OF 12

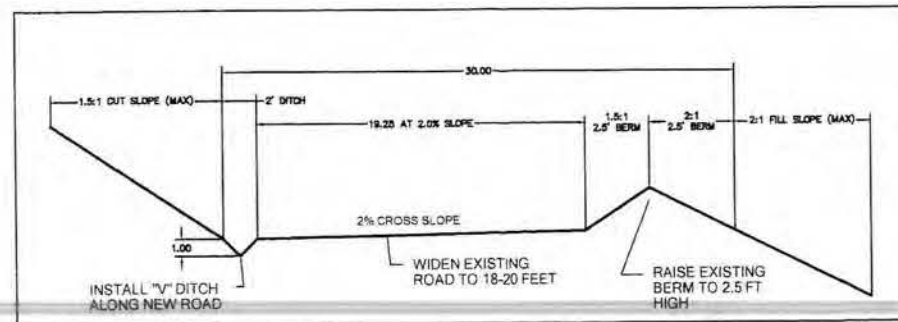
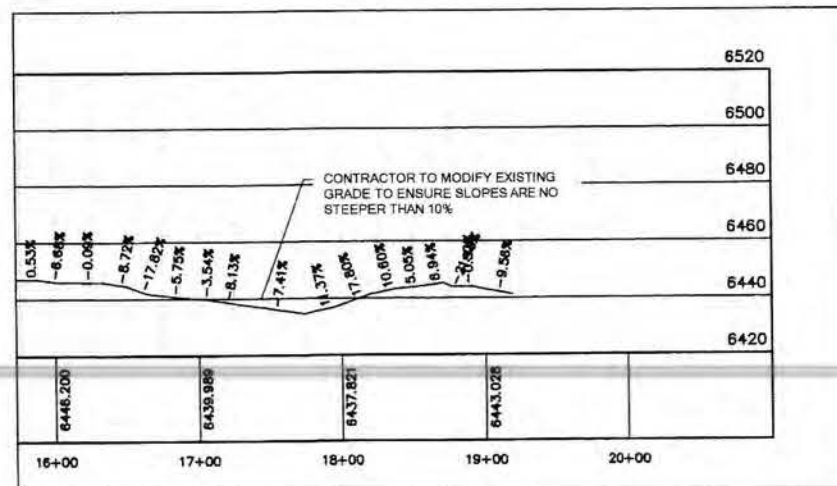
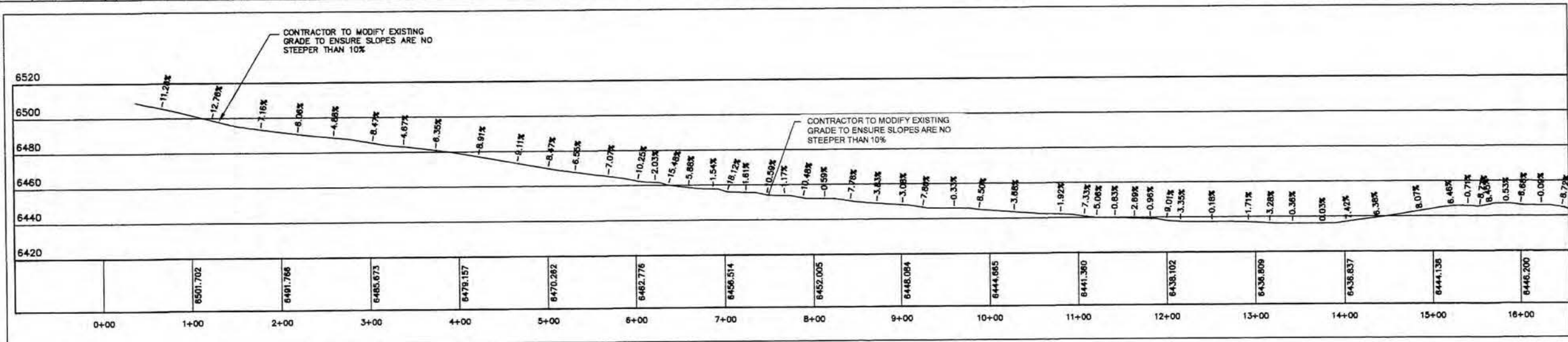

PLotted Date: Lunenburg, 13 August 2013, 1:12pm